



HEWLETT
PACKARD

OPERATING AND SERVICE MANUAL

MODEL 3581A/C WAVE ANALYZER

Serial Number: 1351A00101 (See note below.)

IMPORTANT NOTICE

This loose-leaf manual does not require a change sheet. All change information has been integrated into the manual by page revision. Revised pages are identified by a revision letter in the lower corner of the page. If the serial number of your instrument is lower than the one on this title page, the manual contains revision that may not apply to your instrument. Backdating information in Section VIII adapts the manual to earlier instruments.

Where practical, backdating information is integrated into the schematic diagrams. Backdating changes are denoted by a delta sign. A lettered delta (Δ_A) on a given page, refers to the corresponding backdating note on that page.

If you would like to receive revised pages to update your manual from time to time, please indicate by checking "yes" to Question 17 of the questionnaire in the front of this manual. Be sure to include your name and mailing address on the completed form.

WARNING

To help minimize the possibility of electrical fire or shock hazards, do not expose this instrument to rain or excess moisture.

Manual Part No. 03581-90012

Microfiche Part No. 03581-90090

Valuetronics International, Inc.
1-800-552-8258
MASTER COPY

©Copyright Hewlett-Packard Company 1974
P.O. Box 301, Loveland, Colorado 80537 U.S.A.

Printed: February 1976

CERTIFICATION

Hewlett-Packard Company certifies that this product met its published specifications at the time of shipment from the factory. Hewlett-Packard further certifies that its calibration measurements are traceable to the United States National Bureau of Standards, to the extent allowed by the Bureau's calibration facility, and to the calibration facilities of other International Standards Organization members.

WARRANTY

This Hewlett-Packard product is warranted against defects in material and workmanship for a period of one year from date of shipment [,except that in the case of certain components listed in Section I of this manual, the warranty shall be for the specified period] . During the warranty period, Hewlett-Packard Company will, at its option, either repair or replace products which prove to be defective.

For warranty service or repair, this product must be returned to a service facility designated by -hp-. Buyer shall prepay shipping charges to -hp- and -hp- shall pay shipping charges to return the product to Buyer. However, Buyer shall pay all shipping charges, duties, and taxes for products returned to -hp- from another country.

Hewlett-Packard warrants that its software and firmware designated by -hp- for use with an instrument will execute its programming instructions when properly installed on that instrument. Hewlett-Packard does not warrant that the operation of the instrument, or software, or firmware will be uninterrupted or error free.

LIMITATION OF WARRANTY

The foregoing warranty shall not apply to defects resulting from improper or inadequate maintenance by Buyer, Buyer-supplied software or interfacing, unauthorized modification or misuse, operation outside of the environmental specifications for the product, or improper site preparation or maintenance.

NO OTHER WARRANTY IS EXPRESSED OR IMPLIED. HEWLETT-PACKARD SPECIFICALLY DISCLAIMS THE IMPLIED WARRANTIES OF MERCHANTABILITY AND FITNESS FOR A PARTICULAR PURPOSE.

EXCLUSIVE REMEDIES

THE REMEDIES PROVIDED HEREIN ARE BUYER'S SOLE AND EXCLUSIVE REMEDIES. HEWLETT-PACKARD SHALL NOT BE LIABLE FOR ANY DIRECT, INDIRECT, SPECIAL, INCIDENTAL, OR CONSEQUENTIAL DAMAGES, WHETHER BASED ON CONTRACT, TORT, OR ANY OTHER LEGAL THEORY.

ASSISTANCE

Product maintenance agreements and other customer assistance agreements are available for Hewlett-Packard products.

For any assistance, contact your nearest Hewlett-Packard Sales and Service Office. Addresses are provided at the back of this manual.



SAFETY SUMMARY

The following general safety precautions must be observed during all phases of operation, service, and repair of this instrument. Failure to comply with these precautions or with specific warnings elsewhere in this manual violates safety standards of design, manufacture, and intended use of the instrument. Hewlett-Packard Company assumes no liability for the customer's failure to comply with these requirements. This is a Safety Class 1 instrument.

GROUND THE INSTRUMENT

To minimize shock hazard, the instrument chassis and cabinet must be connected to an electrical ground. The instrument is equipped with a three-conductor ac power cable. The power cable must either be plugged into an approved three-contact electrical outlet or used with a three-contact to two-contact adapter with the grounding wire (green) firmly connected to an electrical ground (safety ground) at the power outlet. The power jack and mating plug of the power cable meet International Electrotechnical Commission (IEC) safety standards.

DO NOT OPERATE IN AN EXPLOSIVE ATMOSPHERE

Do not operate the instrument in the presence of flammable gases or fumes. Operation of any electrical instrument in such an environment constitutes a definite safety hazard.

KEEP AWAY FROM LIVE CIRCUITS

Operating personnel must not remove instrument covers. Component replacement and internal adjustments must be made by qualified maintenance personnel. Do not replace components with power cable connected. Under certain conditions, dangerous voltages may exist even with the power cable removed. To avoid injuries, always disconnect power and discharge circuits before touching them.

DO NOT SERVICE OR ADJUST ALONE

Do not attempt internal service or adjustment unless another person, capable of rendering first aid and resuscitation, is present.

DO NOT SUBSTITUTE PARTS OR MODIFY INSTRUMENT

Because of the danger of introducing additional hazards, do not install substitute parts or perform any unauthorized modification to the instrument. Return the instrument to a Hewlett-Packard Sales and Service Office for service and repair to ensure that safety features are maintained.

DANGEROUS PROCEDURE WARNINGS

Warnings, such as the example below, precede potentially dangerous procedures throughout this manual. Instructions contained in the warnings must be followed.

WARNING

Dangerous voltages, capable of causing death, are present in this instrument. Use extreme caution when handling, testing, and adjusting.

SAFETY SYMBOLS

General Definitions of Safety Symbols Used On Equipment or In Manuals.



Instruction manual symbol: the product will be marked with this symbol when it is necessary for the user to refer to the instruction manual in order to protect against damage to the instrument.



Indicates dangerous voltage (terminals fed from the interior by voltage exceeding 1000 volts must be so marked).

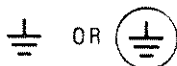

Protective conductor terminal. For protection against electrical shock in case of a fault. Used with field wiring terminals to indicate the terminal which must be connected to ground before operating equipment.



Low-noise or noiseless, clean ground (earth) terminal. Used for a signal common, as well as providing protection against electrical shock in case of a fault. A terminal marked with this symbol must be connected to ground in the manner described in the installation (operating) manual, and before operating the equipment.

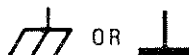

Frame or chassis terminal. A connection to the frame (chassis) of the equipment which normally includes all exposed metal structures.



Alternating current (power line).



Direct current (power line).



Alternating or direct current (power line).

WARNING

The WARNING sign denotes a hazard. It calls attention to a procedure, practice, condition or the like, which, if not correctly performed or adhered to, could result in injury or death to personnel.

CAUTION

The CAUTION sign denotes a hazard. It calls attention to an operating procedure, practice, condition or the like, which, if not correctly performed or adhered to, could result in damage to or destruction of part or all of the product.

NOTE :

The NOTE sign denotes important information. It calls attention to procedure, practice, condition or the like, which is essential to highlight.

SECTION I

GENERAL INFORMATION

1-1. DESCRIPTION.

1-2. The Hewlett-Packard Model 3581A/C Wave Analyzer is a portable instrument designed specifically for use in the audio (15 Hz to 50 kHz) frequency range. As a signal analyzer, the 3581 separates and measures the spectral components of an input signal. By manually tuning the 3581 across the spectrum, the signal components can be individually measured and evaluated. By sweeping the 3581 over the band of interest, a complete spectral display can be plotted with an X-Y recorder connected to the recorder outputs. For added versatility, the 3581 is equipped with a rear panel Tracking Oscillator (BFO) output. When this output is used as an excitation source, the 3581 functions as a network analyzer for plotting the amplitude-vs.-frequency characteristics of 2-port networks such as amplifiers, attenuators and filters.

1-3. The amplitude of the tuned signal is indicated on a large, easy-to-read meter with mirror backing. Absolute amplitude can be read in dBV, dBm or rms volts; relative amplitude can be read in dB or percent. The full-scale sensitivity of the 3581 ranges from 0.1 μ V rms to 100 V rms. For logarithmic measurements, the dynamic range is 80 dB.

1-4. The tuned frequency is indicated by a 5-digit LED readout which provides 1 Hz resolution. If the analyzer is tuned below 0 Hz, the frequency digits blank and the decimal points light to indicate an out of range condition.

1-5. The 3581 has five selectable bandwidths. The 3 Hz, 10 Hz and 30 Hz bandwidths permit separation of closely spaced signals and precise frequency measurements. The 100 Hz and 300 Hz bandwidths permit wide range sweeps at relatively fast sweep rates.

1-6. The 3581 is easy to tune—even when using the 3 Hz bandwidth. Simply tune near the signal to be measured and press the AFC button. The AFC (Automatic Frequency Control) will automatically fine tune the 3581 to the selected signal. Another benefit of AFC is that it locks the analyzer's tuning to the signal so that measurements are not affected by frequency drift. If the AFC becomes unlocked, a front panel annunciator lights to alert the operator that his reading may not be valid.

1-7. The 3581 has a built-in sweep generator which provides for single or repetitive electronic sweeps or manually controlled sweeps. The sweep width or "span" can be varied from 50 Hz to 50 kHz in 10 switch settings. The sweep time can be varied from 0.1 second to 2,000 seconds in 14 settings. A front panel indicator lights

when the sweep rate is too fast for the bandwidth selected (narrower bandwidths require slower sweep rates).

1-8. Comparing the 3581A and 3581C.

1-9. The 3581A is a general purpose instrument designed to solve the traditional problems of wave analysis. The 3581C is a special version of the 3581 designed specifically for communications work. The major difference between the two instruments is the input coupling. The 3581A has a single-ended input with an impedance of 1 megohm, 30 pF. The 3581C has three selectable input configurations: Unbalanced, Balanced-Bridged and Balanced-Terminated. The Unbalanced input impedance is 1 megohm, 40 pF and the Balanced-Bridged input impedance is approximately 15 kilohms. The Balanced-Terminated input impedance is either 900 ohms or 600 ohms as selected by the front panel Calibration switch. The 3581A has a dual banana-plug Input connector while the 3581C has a phone-jack Input requiring a WECO Type 310 mating plug. The 3581A can be calibrated for absolute measurements in dBV, dBm/600 ohms or rms volts. The 3581C can be calibrated for absolute measurements in dBm/900 ohms, dBm/600 ohms or rms volts. It does not have a "dBV" setting. The 3581A has a 600-ohm unbalanced Tracking Oscillator/Restored output; the 3581C has a 600-ohm *balanced* output. Another feature of the 3581C is its Audio Monitor which allows the operator to listen to the restored output signal.

1-10. SPECIFICATIONS.

1-11. Table 1-1 is a complete list of the Model 3581A/C critical specifications that are controlled by tolerances. Table 1-2 contains general information describing the operating characteristics of the 3581.

1-12. Any changes in specifications due to manufacturing, design or traceability to the U.S. National Bureau of Standards are included in Table 1-1 of this manual. Specifications listed in this manual supersede all previous specifications for the Model 3581A/C.

1-13. OPTION.

1-14. The 3581A/C Option 001 is equipped with an internal rechargeable battery pack for complete portability. This option is field installable. Order: Field Installation Kit, -hp-11195A.

1-15. Warranty Exception.

1-16. The batteries in Option 001 instruments are warranted for 90 days.

1-17. ACCESSORIES SUPPLIED.

1-18. The following is a list of accessories supplied with the 3581A/C:

Item	Qty.	-hp- Part No.
Accessory Kit Includes the following:	1 ea.	03580-84401
PC Board Extender (15 pin)	2 ea.	5060-0049
PC Board Extender (10 pin)	2 ea.	5060-5917
Fuse: 0.25 A, 250 V Normal Blo (for 220 V/240 V operation)	1 ea.	2110-0004

1-19. ACCESSORIES AVAILABLE.

1-20. The following is a list of Hewlett-Packard accessories available for use with the 3581A/C:

Accessory	-hp- Model
X-Y Recorder	7035B Option 020
Oscilloscope	1201A/B
Oscilloscope Camera	197A or 198A
Voltage Divider Probe	10004B
Testmobile	1001A
Rack Mount Kit	3580A/K05

1-21. INSTRUMENT AND MANUAL IDENTIFICATION.

1-22. The instrument serial number is located on the rear panel. Hewlett-Packard uses a two-section serial number consisting of a four-digit prefix and a five-digit suffix. A letter between the suffix and prefix identifies the country in which the instrument was manufactured (A = USA, G = West Germany, J = Japan, U = United Kingdom). All correspondence with Hewlett-Packard should include the complete serial number.

1-23. If the serial number of your instrument is lower than the one on the title page of this manual, refer to Section VIII for backdating information that will adapt this manual to your instrument.

Table 1-1. Specifications.

<p>FREQUENCY</p> <p>Display Accuracy: ± 3 Hz</p> <p>AFC Pull-In Range: $> 5 \times$ Bandwidth for 3 Hz thru 100 Hz Bandwidth; > 800 Hz for 300 Hz Bandwidth.</p> <p>AFC Hold-In Range: ± 800 Hz</p> <p>AFC Lock Frequency: center of passband ± 1 Hz</p> <p>AMPLITUDE</p> <p>Amplitude Accuracy:</p> <table border="1"> <thead> <tr> <th>Frequency Response</th> <th>LOG</th> <th>LINEAR</th> </tr> </thead> <tbody> <tr> <td>3581A and 3581C Unbalanced 15 Hz to 50 kHz</td> <td>± 0.4 dB</td> <td>$\pm 4\%$</td> </tr> <tr> <td>3581C Balanced Inputs:*, 40 Hz to 20 kHz, + 20 dBm max</td> <td>± 0.5 dB</td> <td>$\pm 5\%$</td> </tr> <tr> <td>Switching Between Bandwidths:</td> <td>± 0.5 dB</td> <td>$\pm 5\%$</td> </tr> <tr> <td>Amplitude Display:</td> <td>± 2 dB</td> <td>$\pm 2\%$</td> </tr> <tr> <td>Input Attenuator:</td> <td>± 0.3 dB</td> <td>$\pm 3\%$</td> </tr> <tr> <td>Amplitude Reference Level (IF Attenuator)</td> <td></td> <td></td> </tr> <tr> <td>Most Sensitive Range:</td> <td>± 1 dB</td> <td>$\pm 10\%$</td> </tr> <tr> <td>All Other Ranges:</td> <td>± 1 dB</td> <td>$\pm 3\%$</td> </tr> </tbody> </table> <p>*for signals below + 20 dBm</p> <p>Dynamic Range:</p> <p>Display Range (90 dB scale): > 80 dB</p> <p>Noise Level:</p>	Frequency Response	LOG	LINEAR	3581A and 3581C Unbalanced 15 Hz to 50 kHz	± 0.4 dB	$\pm 4\%$	3581C Balanced Inputs:*, 40 Hz to 20 kHz, + 20 dBm max	± 0.5 dB	$\pm 5\%$	Switching Between Bandwidths:	± 0.5 dB	$\pm 5\%$	Amplitude Display:	± 2 dB	$\pm 2\%$	Input Attenuator:	± 0.3 dB	$\pm 3\%$	Amplitude Reference Level (IF Attenuator)			Most Sensitive Range:	± 1 dB	$\pm 10\%$	All Other Ranges:	± 1 dB	$\pm 3\%$	<p>Noise Sidebands: > 70 dB below CW signal 10 Bandwidths away from signal.</p> <p>Spurious Responses: > 80 dB for signals less than 0 dBm above 100 Hz.</p> <p>Line-Related Spurious: > 80 dB below input reference level or - 140 dBV (0.1 μV). Below - 90 dBm for 3581C Balanced-Terminated input.</p> <p>IF Feedthru:</p> <table border="1"> <thead> <tr> <th>Input</th> <th>Feedthru</th> </tr> </thead> <tbody> <tr> <td>> 10 V</td> <td>- 60 dB or lower</td> </tr> <tr> <td>< 10 V</td> <td>- 70 dB or lower</td> </tr> </tbody> </table> <p>Zero Response: > 30 dB below input reference level</p> <p>BALANCED INPUT (3581C only)</p> <p>Frequency Response: 40 Hz to 20 kHz ± 0.5 dB for signals below + 20 dBm</p> <p>Common Mode Rejection: > 64 dB at 60 Hz</p> <p>OUTPUTS</p> <p>Recorder Outputs:</p> <p>X-Axis: 0 V to + 5 V $\pm 2.5\%$ Y-Axis: 0 V to + 5 V $\pm 2.5\%$</p> <p>Tracking Oscillator Output</p> <p>Frequency Accuracy: ± 1 Hz relative to center of passband</p> <p>Frequency Response 3581A: $\pm 3\%$ 15 Hz to 50 kHz 3581C: ± 0.5 dB 100 Hz to 20 kHz, 10 kHz reference, into 600 Ω load</p> <p>THD and Spurious: > 40 dB below 1 V signal level</p>	Input	Feedthru	> 10 V	- 60 dB or lower	< 10 V	- 70 dB or lower
Frequency Response	LOG	LINEAR																																
3581A and 3581C Unbalanced 15 Hz to 50 kHz	± 0.4 dB	$\pm 4\%$																																
3581C Balanced Inputs:*, 40 Hz to 20 kHz, + 20 dBm max	± 0.5 dB	$\pm 5\%$																																
Switching Between Bandwidths:	± 0.5 dB	$\pm 5\%$																																
Amplitude Display:	± 2 dB	$\pm 2\%$																																
Input Attenuator:	± 0.3 dB	$\pm 3\%$																																
Amplitude Reference Level (IF Attenuator)																																		
Most Sensitive Range:	± 1 dB	$\pm 10\%$																																
All Other Ranges:	± 1 dB	$\pm 3\%$																																
Input	Feedthru																																	
> 10 V	- 60 dB or lower																																	
< 10 V	- 70 dB or lower																																	

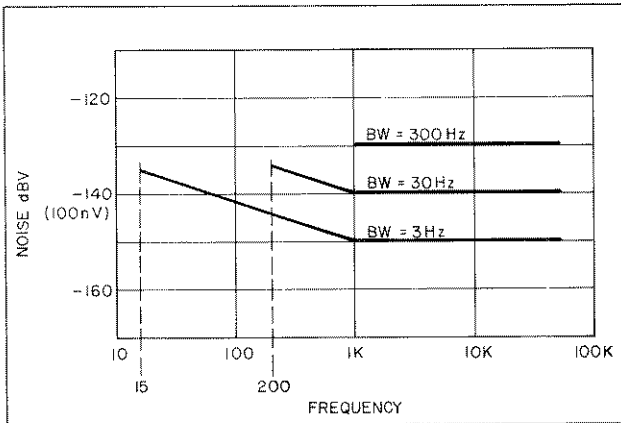
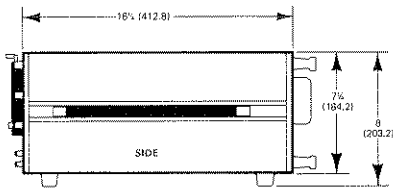
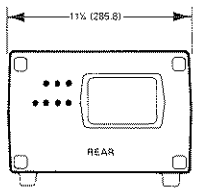

Table 1-2. General Information.

<p>INPUT CHARACTERISTICS (3581A)</p> <p>Connector: female banana plug</p> <p>Impedance: 1 megohm, 30 pF</p> <p>Maximum (ac) Input Level:</p> <table border="0"> <thead> <tr> <th style="text-align: center;">Input Sensitivity</th> <th style="text-align: center;">Maximum Input</th> </tr> </thead> <tbody> <tr> <td>+ 30 dB (20 V) to - 10 dB (0.2 V)</td> <td>100 V rms</td> </tr> <tr> <td>- 20 dB (0.1 V) to - 70 dB (0.2 mV)</td> <td>50 V rms</td> </tr> </tbody> </table> <p>Maximum (dc) Input Voltage: ± 100 V dc</p> <p>Coupling: capacitive</p> <p>DC Isolation: none (input common referenced to frame ground)</p>	Input Sensitivity	Maximum Input	+ 30 dB (20 V) to - 10 dB (0.2 V)	100 V rms	- 20 dB (0.1 V) to - 70 dB (0.2 mV)	50 V rms	<p>Full-Scale Sensitivity:</p> <p>Volts Scale:</p> <p style="padding-left: 20px;">Calibrated: 30 V rms to 0.1 μV rms (18 ranges) Uncalibrated: 100 V rms to 0.2 μV rms</p> <p>Log 90 dB Scale:</p> <p style="padding-left: 20px;">Calibrated: + 30 dBV/dBm to - 70 dBV/dBm (11 ranges) Uncalibrated: + 40 dBV/dBm to - 60 dBV/dBm</p> <p>Overload Indicator: An LED Overload indicator on the front panel lights to indicate that the input signal exceeds the maximum (full scale) input level set by the INPUT SENSITIVITY switch and amplitude VERNIER.</p> <p>Internal Calibration Signal: An internally generated calibration signal can be used to calibrate the amplitude section (following input attenuator) to an accuracy of ± 1.5% at 10 kHz. The calibration signal can also be used to verify the frequency accuracy of the instrument.</p>
Input Sensitivity	Maximum Input						
+ 30 dB (20 V) to - 10 dB (0.2 V)	100 V rms						
- 20 dB (0.1 V) to - 70 dB (0.2 mV)	50 V rms						
<p>INPUT CHARACTERISTICS (3581C)</p> <p>Selectable Input Configurations:</p> <ul style="list-style-type: none"> Unbalanced Balanced Bridged Balanced Terminated <p>Connector: accepts WECO Type 310 mating plug</p> <p>Impedance:</p> <p style="padding-left: 20px;">Unbalanced: 1 megohm, 40 pF Bridged: greater than 12 K (typically 14 K at 1 kHz) Terminated: 600 ohms or 900 ohms</p> <p>Maximum Input Levels:</p> <p style="padding-left: 20px;">Unbalanced: same as 3581A Bridged: 100 vdc max, 35 vrms ac max Terminated: + 27 dBm, at 0 V dc</p> <p>DC Isolation:</p> <p style="padding-left: 20px;">Unbalanced: none (input common referenced to frame ground) Bridged and Terminated: floating input</p>	<p>FREQUENCY CHARACTERISTICS:</p> <p>Frequency Range: 15 Hz to 50 kHz</p> <p>Frequency Control: The front panel FREQUENCY control tunes the frequency of the analyzer over the 0 Hz to 50 kHz range. The control can be used to set the start frequency of electronic or manual sweeps.</p> <p>Coarse or Fine Tuning: Coarse tuning is selected by pushing the crank toward the front panel; fine tuning is selected by pulling the crank outward. In the coarse position, one revolution of the crank changes the frequency by approximately 2.7 kHz. In the fine position, one revolution of the crank changes the frequency by approximately 73 Hz.</p> <p>Frequency Display: 5-digit LED display indicates tuned frequency in Hz.</p> <p>Accuracy: ± 3 Hz</p> <p>Range: 0 Hz to approximately 51,000 Hz</p> <p>Out of Range Indication: Frequency digits blank and decimal points light when frequency is tuned below 0 Hz.</p> <p>Typical Frequency Stability: ± 10 Hz/hr. after 1 hour; ± 5 Hz/^oC</p> <p>Remote Tuning: 3581A/C can be remotely tuned by applying an externally generated 1 MHz to 1.5 MHz signal to L.O. IN connector.</p> <p>Bandwidth Settings: 3 Hz, 10 Hz, 30 Hz, 100 Hz, 300 Hz</p> <p>Bandpass Characteristic: closely approximates a gaussian response.</p> <p>Shape Factor: 10:1 on 3 Hz thru 100 Hz bandwidths; 8:1 on 300 Hz bandwidth</p> <p>Equivalent Noise Bandwidth: Typically 12% wider than <i>absolute</i> 3 dB bandwidth.</p>						
<p>AMPLITUDE CHARACTERISTICS:</p> <p>Scale Settings:</p> <p>Volts: Absolute measurements in rms volts (average responding); relative measurements in percent of full scale.</p> <p>Log 90 dB:</p> <p style="padding-left: 20px;">3581A: Absolute measurements in dBV (1 V rms = 0 dBV) or dBm/600 ohms; relative measurements in dB.</p> <p style="padding-left: 20px;">3581C: Absolute measurements in dBm/900 ohms or dBm/600 ohms; relative measurements in dB.</p> <p style="padding-left: 20px;">Display Range: 80 dB</p> <p>Log 10 dB: Display sensitivity is 1 dB per division; display range is 10 dB. Any 10 dB portion of 80 dB range can be displayed by changing AMPLITUDE REF LEVEL setting.</p>	<p>Display Smoothing (noise filtering):</p> <p style="padding-left: 20px;">3 Settings: min, med max</p> <p style="padding-left: 20px;">Response: determined by Bandwidth setting.</p>						

Table 1-2. General Information (Cont'd).

<p>Automatic Frequency Control (AFC):</p> <p>Typical Pull-In Range: see Table 3-5 (Section III) Hold-In Range: ± 800 Hz (frequency drift rate below maximum drift rate listed in following table) Maximum Drift Rate:</p> <table border="1" style="margin-left: 20px;"> <thead> <tr> <th>BANDWIDTH</th> <th>MAXIMUM DRIFT RATE</th> </tr> </thead> <tbody> <tr> <td>300 Hz</td> <td>400 Hz/sec</td> </tr> <tr> <td>100 Hz</td> <td>400 Hz/sec</td> </tr> <tr> <td>30 Hz</td> <td>40 Hz/sec</td> </tr> <tr> <td>10 Hz</td> <td>4 Hz/sec</td> </tr> <tr> <td>3 Hz</td> <td>0.4 Hz/sec</td> </tr> </tbody> </table> <p>Lock Frequency: center of passband ± 1 Hz</p> <p>SWEEP CHARACTERISTICS:</p> <p>Sweep Modes:</p> <p>Repetitive: The instrument sweeps continuously over the selected frequency range. Single: The instrument sweeps one time over the selected frequency range and stops at the end frequency. Reset: Sweep is reset; instrument remains at start frequency of sweep. Manual: The electronic sweep is disabled and a front panel potentiometer is used to manually sweep the frequency. Off: Sweep circuits disabled.</p> <p>Frequency Span Settings: 0 Hz*, 50 Hz to 50 kHz (10 settings)</p> <p>*When the 0 Hz span setting is selected, the instrument remains at the frequency indicated on the frequency display. The sweep generator, however, remains operative and an X-Y recorder or scope connected to the X-Axis recorder output can be swept at the rate selected by the SWEEP TIME control. This provides a graphical display of amplitude vs. time.</p> <p>Typical Frequency Span Accuracy: $\pm 2\%$ of setting</p> <p>Sweep Time Settings: 0.1 sec to 2,000 sec (14 settings)</p> <p>Typical Sweep Time Accuracy: $\pm 5\%$ of setting</p> <p>Typical Sweep Linearity: $\pm 1\%$</p> <p>Sweep Error Light: A front panel LED indicator lights when sweep rate is too fast.</p> <p>External Triggering: A rear panel External Trigger input is provided to allow the frequency sweep to be remotely triggered using a contact closure or TTL output. External triggering can be used in the Single or Repetitive mode.</p> <p>OUTPUTS</p> <p>Recorder Outputs:</p> <p>X-Axis: Supplies dc voltage proportional to frequency sweep.</p> <p>Output Voltage: 0 V (start freq.) to + 5 V (end freq.) Output Resistance: 1 kilohm</p>	BANDWIDTH	MAXIMUM DRIFT RATE	300 Hz	400 Hz/sec	100 Hz	400 Hz/sec	30 Hz	40 Hz/sec	10 Hz	4 Hz/sec	3 Hz	0.4 Hz/sec	<p>Y-Axis: Supplies dc voltage proportional to meter reading.</p> <p>Output Voltage: 0 V to + 5 V full scale Output Resistance: 1 kilohm</p> <p>Tracking Oscillator/Restored Output</p> <p>Frequency: 15 Hz to 50 kHz; tracks tuned or swept frequency of instrument.</p> <p>Output Level:</p> <p>Tracking Oscillator: constant level signal; can be adjusted from 0 V to > 1 V rms into 600 Ω Restored: proportional to signal being measured; full-scale level adjustable from 0 V to > 1 V rms into 600 Ω Flatness: ± 0.5 dB 100 Hz to 20 kHz, 10 kHz reference, 600 ohm load</p> <p>Output Impedance:</p> <p>3581A: 600 ohms, unbalanced 3581C: 600 ohms, balanced</p> <p>L.O. Output:</p> <p>Frequency: Varies from 1.0 MHz to 1.5 MHz as 3581 frequency is tuned from 0 Hz to 50 kHz. Output Level: 100 mV rms, nominal value, varies with frequency Output Impedance: 1 kilohm</p> <p>GENERAL:</p> <p>Operating Temperature Range:</p> <p>Standard 3581: 0°C to + 55°C Option 001: 0°C to + 40°C</p> <p>Storage Temperature Range:</p> <p>Standard 3580A - 40°C to + 75°C Option 001: - 40°C to + 50°C</p> <p>Charge Temperature Range (Option 001): 0°C to + 40°C</p> <p>Power Requirements: 100 V, 120 V, 220V or 240 V + 5% - 10%, 48 Hz to 66 Hz, 10 watts typical</p> <p>Battery Characteristics (Option 001):</p> <p>Operating Time: 12 hours from full charge Charge Time: 14 hours to recharge fully discharged battery pack Battery Life: more than 100 charge/discharge cycles Protection: The batteries are protected from excessive discharge by an automatic cut out.</p> <p>Dimensions:</p> <p style="text-align: center; font-size: small;">DIMENSIONS SHOWN IN INCHES AND (MILLIMETERS)</p> <div style="display: flex; justify-content: space-around;">   </div>
BANDWIDTH	MAXIMUM DRIFT RATE												
300 Hz	400 Hz/sec												
100 Hz	400 Hz/sec												
30 Hz	40 Hz/sec												
10 Hz	4 Hz/sec												
3 Hz	0.4 Hz/sec												

C

C

E

SECTION II INSTALLATION

2-1. INTRODUCTION.

2-2. This section contains information and instructions necessary for installing and shipping the Model 3581A/C Wave Analyzer. Included are initial inspection procedures, power and grounding requirements, environmental information, installation instructions and instructions for repackaging for shipment.

2-3. INITIAL INSPECTION.

2-4. This instrument was carefully inspected both mechanically and electrically before shipment. It should be free of marks or scratches and in perfect electrical order upon receipt. To confirm this, the instrument should be inspected for physical damage incurred in transit. If the instrument was damaged in transit, file a claim with the carrier. Check for supplied accessories (Paragraph 1-17) and test the electrical performance of the instrument using the performance test procedures outlined in Section V. If there is damage or deficiency, see the warranty in the front of this manual.

2-5. POWER REQUIREMENTS.

2-6. The Model 3581A/C can be operated from any power source supplying 100 V, 120 V, 220 V or 240 V (+ 5% - 10%), 48 Hz to 440 Hz. Power dissipation is about 10 watts. Refer to Paragraph 3-168 (Section III) for the Instrument Turn On procedure.

2-7. Power Cords and Receptacles.

2-8. Figure 2-1 illustrates the standard power receptacle (wall outlet) configurations that are used throughout the United States and in other countries. The -hp- part number shown directly below each receptacle drawing is the part number for a power cord equipped with the appropriate mating plug for that receptacle. If the appropriate power cord is not included with the instrument, notify the nearest

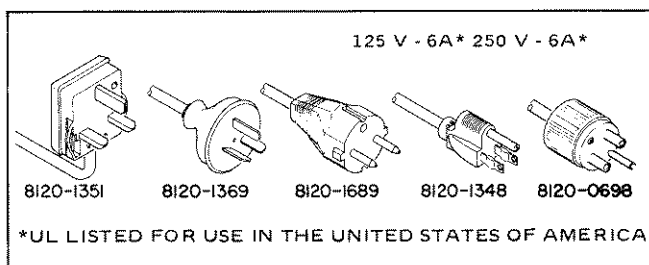

Figure 2-1. Power Receptacles.

-hp- Sales and Service Office and a replacement cord will be provided.

2-9. GROUNDING REQUIREMENTS.

2-10. To protect operating personnel, the National Electrical Manufacturer's Association (NEMA) recommends that the instrument panel and cabinet be grounded. The Model 3581 is equipped with a three conductor power cable which, when plugged into an appropriate receptacle, grounds the instrument. The offset pin on the power plug is the ground connection.

2-11. For battery powered instruments (Option 001), the common binding post of the INPUT connector (Case Ground ∇) should be connected to earth ground or to an appropriate system ground. *If a system ground is used, extra care should be taken to ensure that it is actually at ground potential and is not a voltage source.*

2-12. The 3581 power cord, power input receptacle and mating connectors meet the safety standards set forth by the International Electrotechnical Commission (IEC).

2-13. ENVIRONMENTAL REQUIREMENTS.

2-14. Operating and Storage Temperature (Standard 3581).

Operating Temperature Range: 0°C to + 55°C
Storage Temperature Range: - 40°C to + 75°C

2-15. Operating and Storage Temperature (Option 001).

Operating Temperature Range: 0°C to + 40°C
Storage Temperature Range: - 40°C to + 50°C
Charge Temperature Range: 0°C to + 40°C

2-16. INSTALLATION.

2-17. The Model 3581 is a portable instrument and does not require installation. The instrument is shipped with rubber feet and tilt stand in place, ready for use as a bench instrument.

2-18. REPACKAGING FOR SHIPMENT.

2-19. The following paragraphs contain a general guide for repackaging the instrument for shipment. Refer to Para-

graph 2-20 if the original container is to be used; 2-21 if it is not. If you have any questions, contact the nearest -hp- Sales and Service Office (See Appendix B for office locations).

NOTE

If the instrument is to be shipped to Hewlett-Packard for service, or repair, attach a tag to the instrument identifying the owner and indicating the service or repair to be accomplished. Include the model number and full serial number of the instrument. In any correspondence, identify the instrument by model number and full serial number.

2-20. Place instrument in original container with appro-

prate packing material and seal well with strong tape or metal bands.

2-21. If original container is not to be used, proceed as follows:

a. Wrap instrument in heavy paper, or plastic before placing in an inner container.

b. Place packing material around all sides of instrument and protect panel face with cardboard strips.

c. Place instrument and inner container in a heavy carton or wooden box and seal with strong tape or metal bands.

d. Mark shipping container "DELICATE INSTRUMENT," "FRAGILE," etc.

PERFORMANCE TEST CARD

Hewlett-Packard Model 3581A/C

Tests Performed By _____

Wave Analyzer

Serial No. _____

Date _____

FREQUENCY TESTS

Step	Record	Test Limits	Parameter
g.	Counter Reading: _____ Hz	10,000 Hz \pm 1 Hz	Tracking Osc. Freq.
i.	Frequency Display: _____ Hz	10,000 Hz \pm 3 Hz	Freq. Display Accuracy
k.	Counter Reading: _____ Hz	Step g \pm 1 Hz	AFC Lock Frequency
m.	Pass Fail	-----	Pull-In Range 300 Hz BW
n.	Pass Fail	-----	
p.	Pass Fail	-----	Pull-In Range 3 Hz BW
q.	Pass Fail	-----	
s.	Pass Fail	-----	Pull-In Range 100 Hz BW
u.	Frequency Display: _____ Hz	8,700 Hz to 9,200 Hz	Hold-In Range
v.	Pass Fail	-----	Pull-In Range 100 Hz BW
x.	Frequency Display: _____ Hz	10,800 Hz to 11,300 Hz	Hold-In Range

BANDWIDTH TEST

Bandwidth	Lower 3 dB Point	Upper 3 dB Point	Absolute 3 dB BW	Test Limits
300 Hz	_____ Hz	_____ Hz	_____ Hz	\pm 45 Hz
100 Hz	_____ Hz	_____ Hz	_____ Hz	\pm 15 Hz
30 Hz	_____ Hz	_____ Hz	_____ Hz	\pm 4.5 Hz
10 Hz	_____ Hz	_____ Hz	_____ Hz	\pm 1.5 Hz
3 Hz	_____ Hz	_____ Hz	_____ Hz	\pm 0.4 Hz

FREQUENCY SPAN TEST

Freq. Span	Freq. Reading	Test Limits (Hz)
50 Hz	_____ Hz	1,049 – 1,051
100 Hz	_____ Hz	1,098 – 1,102
200 Hz	_____ Hz	1,196 – 1,204
500 Hz	_____ Hz	1,490 – 1,510
1 kHz	_____ Hz	1,980 – 2,020
2 kHz	_____ Hz	2,960 – 3,040
5 kHz	_____ Hz	5,900 – 6,100
10 kHz	_____ Hz	10,900 – 11,200
20 kHz	_____ Hz	19,600 – 21,400
50 kHz	_____ Hz	50,000 – 52,000

BANDWIDTH SWITCHING TEST

Test Limit: - 5 dB \pm 0.5 dB

Bandwidth	Meter reading
100 Hz	_____ dB
30 Hz	_____ dB
10 Hz	_____ dB
3 Hz	_____ dB

PERFORMANCE TEST CARD (cont'd)

AMPLITUDE DISPLAY TEST (Log Scale)

Input Level	Meter Reading	Test Limits
- 10 dBV	_____ dB	- 10 dB ± 2 dB
- 20 dBV	_____ dB	- 20 dB ± 2 dB
- 30 dBV	_____ dB	- 30 dB ± 2 dB
- 40 dBV	_____ dB	- 40 dB ± 2 dB
- 50 dBV	_____ dB	- 50 dB ± 2 dB
- 60 dBV	_____ dB	- 60 dB ± 2 dB
- 70 dBV	_____ dB	- 70 dB ± 2 dB
- 80 dBV	_____ dB	- 80 dB ± 2 dB

AMPLITUDE REF LEVEL TEST (Volts Scale)

Test Limits: 0.9 V ± 0.03 V (- 10 dB thru - 60 dB);
0.9 V ± 0.1 V (- 70 dB)

Amplitude Ref Level	Meter Reading
- 10 dB	_____ V
- 20 dB	_____ V
- 30 dB	_____ V
- 40 dB	_____ V
- 50 dB	_____ V
- 60 dB	_____ V
- 70 dB	_____ V

AMPLITUDE DISPLAY TEST (Volts Scale)

Input Level	Meter Reading	Test Limits
0.9 V	_____ V	0.9 V ± 0.02 V
0.8 V	_____ V	0.8 V ± 0.02 V
0.7 V	_____ V	0.7 V ± 0.02 V
0.6 V	_____ V	0.6 V ± 0.02 V
0.5 V	_____ V	0.5 V ± 0.02 V
0.4 V	_____ V	0.4 V ± 0.02 V
0.3 V	_____ V	0.3 V ± 0.02 V
0.2 V	_____ V	0.2 V ± 0.02 V
0.1 V	_____ V	0.1 V ± 0.02 V

AMPLITUDE REF LEVEL TEST (Log Scale)

Test Limit: - 5 dB ± 1 dB

Amplitude Ref Level	Meter Reading
- 10 dB	_____ dB
- 20 dB	_____ dB
- 30 dB	_____ dB
- 40 dB	_____ dB
- 50 dB	_____ dB
- 60 dB	_____ dB
- 70 dB	_____ dB

INPUT ATTENUATOR TEST

Input Sensitivity	Step	Meter Reading	Test Limits
+ 30 dB	f	_____ dB	-----
+ 20 dB	h	_____ dB	Step f ± 0.3 dB
+ 20 dB	j	_____ dB	-----
+ 10 dB	l	_____ dB	Step j ± 0.3 dB
+ 10 dB	n	_____ dB	-----
0 dB	p	_____ dB	Step n ± 0.3 dB
- 10 dB	s	_____ dB	- 5 dB ± 0.3 dB
- 20 dB	s	_____ dB	- 5 dB ± 0.3 dB
- 30 dB	s	_____ dB	- 5 dB ± 0.3 dB
- 40 dB	s	_____ dB	- 5 dB ± 0.3 dB
- 50 dB	s	_____ dB	- 5 dB ± 0.3 dB
- 60 dB	s	_____ dB	- 5 dB ± 0.3 dB
- 70 dB	s	_____ dB	- 5 dB ± 0.3 dB

SECTION III OPERATING INSTRUCTIONS

3-1. INTRODUCTION.

3-2. This section contains complete operating instructions for the Model 3581 Wave Analyzer. Included is a brief description of the instrument, a description of controls, general operating information and basic operating procedures. Most of the information in this section applies to both the 3581A and the communications option 3581C. However, before using the 3581C refer to Paragraph 3-156 for details concerning its special features.

3-3. ABOUT THE WAVE ANALYZER.

3-4. The first wave analyzers, introduced in the early 1930's, consisted of tunable filters that were used in conjunction with broadband voltmeters to separate and measure the frequency components of signals. Although the "tunable filter" principle still applies, modern wave analyzers have greatly improved performance features. These include high sensitivity, wide dynamic range and selectable bandwidths. The improved performance features, along with operating conveniences such as automatic frequency control, electronic sweep and digital frequency readout,

make today's wave analyzers easy to use instruments with unlimited applications in both the RF and audio frequency ranges.

3-5. The 3581 is a low frequency wave analyzer designed specifically for use in the audio frequency range. The major performance features of the instrument include 15 Hz to 50 kHz frequency range, 0.1 μ V full-scale sensitivity, 80 dB dynamic range and five selectable bandwidths ranging from 3 Hz to 300 Hz. In addition, the 3581 is equipped with automatic frequency control, electronic sweep, digital frequency readout, recorder outputs and a tracking oscillator (BFO) output. Details of these and other features outlined in Table 3-1 are given in the General Operating section.

3-6. CONTROLS, CONNECTORS AND INDICATORS.

3-7. Figures 3-1 and 3-2 illustrate and describe the function of all front and rear panel controls, connectors and indicators. Items requiring additional description are referenced to paragraphs in the General Operating Information section.

Table 3-1. Operating Features.

FEATURE	PARAGRAPH	FEATURE	PARAGRAPH
High Input Impedance: 1 Megohm, 30 pF	3-11	3. Log 10 dB: expanded scale 1 dB/div; 10 dB meter range.	3-55
Frequency Range: 15 Hz to 50 kHz		Wide Measurement Range:	
Five Selectable Bandwidths: 3 Hz - 300 Hz	3-80	1. Calibrated: 0.1 μ V rms (-140 dBV/dBm) full scale to 30 V rms (+30 dBV/dBm) full scale.	
Digital Frequency Display	3-97	2. Uncalibrated: 0.1 μ V rms full scale to 100 V rms full scale.	
Automatic Frequency Control	3-99	80 dB Dynamic Range	3-46
Eleven Frequency Span Settings: 0 Hz, 50 Hz - 50 kHz	3-106	Internal Calibration Signal	3-77
Sweep Modes:	3-111	Recorder Outputs	3-133
1. Single or repetitive linear sweep.		Tracking Oscillator/Restored Output	3-139
2. Manual sweep.		Audio Monitor (3581C)	3-164
Fourteen Sweep Time Settings: 0.1 sec. to 2,000 sec.	3-119	Local Oscillator Output	3-144
Optimum Sweep Rate Indicator	3-124	Local Oscillator Input	3-148
Three Scale Settings:		Portability, Battery Operation (Option 001)	3-151
1. Linear: absolute measurements in rms volts; relative measurements in percent of full scale.	3-52	Balanced Inputs: Balanced Tracking Output (3581C)	3-156
2. Log 90 dB: absolute measurements in dBV or dBm/600 ohms; relative measurements in dB; 80 dB dynamic range.	3-53		

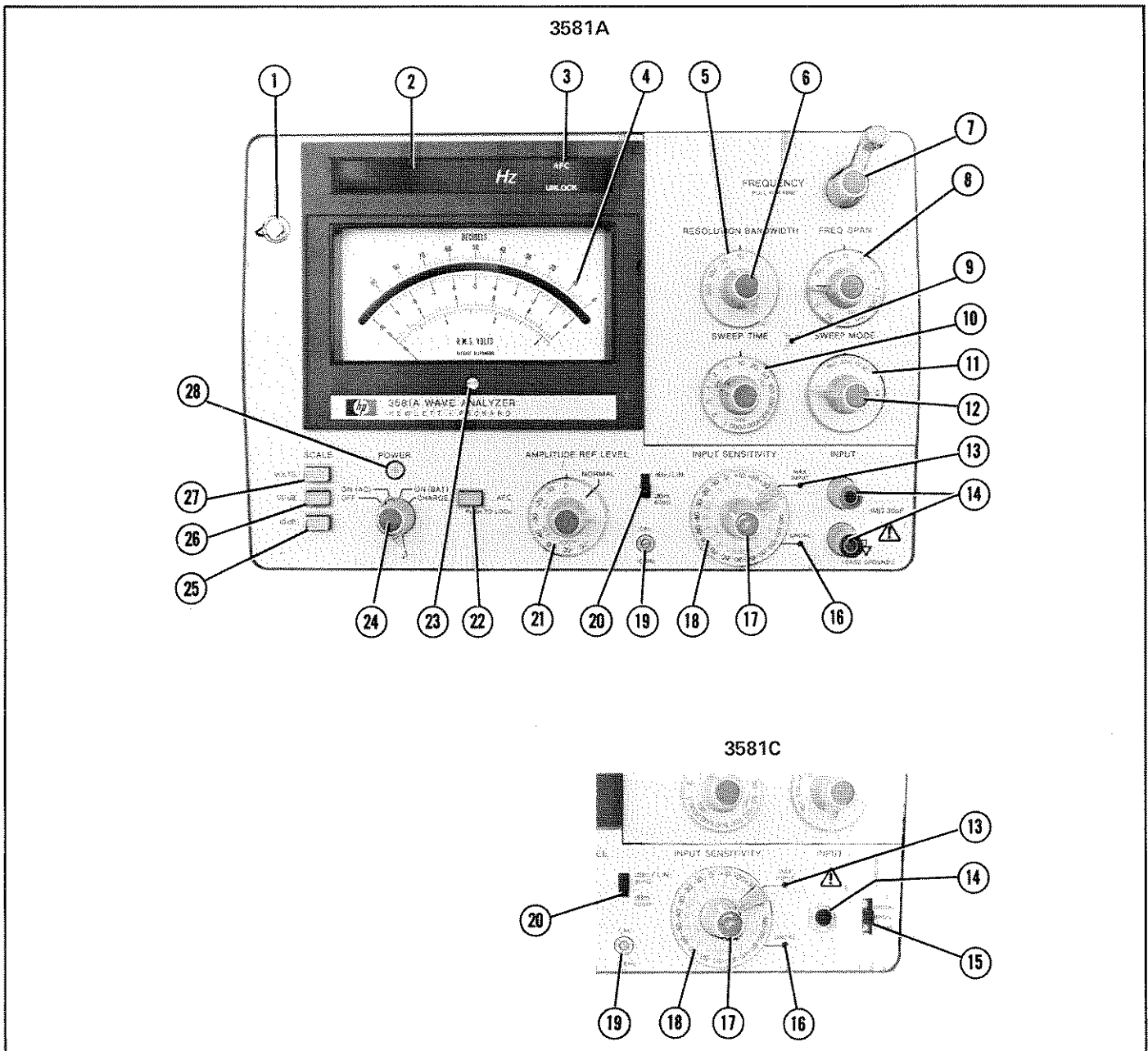

- ① AUDIO LEVEL Control (3581C only): Adjusts volume for audio monitor. (Paragraph 3-164)
- ② Frequency Display: Indicates tuned frequency in Hz. Display accuracy is ± 3 Hz; time base is 0.2 second. Frequency digits blank and decimal points light when analyzer is tuned below 0 Hz. (Paragraph 3-97)
- ③ AFC UNLOCK Annunciator: Lights when AFC is not locked to a signal. (Paragraph 3-105)
- ④ Meter: Has taut-band movement and special calibrated scales with mirror backing. Scales include 0 to 1 and 0 to 3 linear (volts) scales and 0 dB to -90 dB and 0 dB to -10 dB log scales. (Paragraph 3-50)
- ⑤ BANDWIDTH Switch: Controls 3 dB bandwidth of IF Filter. Is used to select the desired frequency resolution. The 5 BANDWIDTH settings are: 300 Hz, 100 Hz, 30 Hz, 10 Hz and 3 Hz. (Paragraph 3-80)

- ⑥ DISPLAY SMOOTHING Switch: Provides 3 levels of noise filtering for meter display and Y-Axis recorder output. Response time becomes longer as smoothing is increased.
- ⑦ FREQUENCY Control: Tunes analyzer frequency from 0 Hz to 50 kHz. Sets start frequency for electronic or manual sweep. Push in for coarse tuning; pull out for fine tuning. (Paragraph 3-97)
- ⑧ FREQ SPAN Control: Sets scan width for electronic or manual sweeps. Span settings range from 50 Hz to 50 kHz. (Paragraph 3-106)
- ⑨ ADJUST Indicator. Lights to indicate that sweep rate is too fast. Will go out when SWEEP TIME is increased, BANDWIDTH is widened or FREQ SPAN is narrowed. (Paragraph 3-124)
- ⑩ SWEEP TIME Control: Sets time duration for single or repetitive sweeps. Settings range from 0.1 second to 2,000 seconds. (Paragraph 3-119)

Figure 3-1. Front Panel.

- 11 SWEEP MODE Switch: Selects Repetitive, Single, Reset, Manual or Off sweep mode. (Paragraph 3-111)
- 12 MANUAL VERNIER. Tunes analyzer frequency when SWEEP MODE switch is set to Manual (MAN) position. Manual sweep fully duplicates the span of the electronic sweep. (Paragraph 3-117)
- 13 OVERLOAD Indicator. Lights when input signal exceeds maximum input level set by INPUT SENSITIVITY switch and Amplitude VERNIER control. (Paragraph 3-36)
- 14 INPUT Connector
 3581A: Accepts male banana-plug connector; input impedance is 1 megohm, 30 pF. (Paragraph 3-9)

 3581C: Accepts WECO Type 310 (or equiv.) mating plug. For unbalanced input, Tip is signal; Ring and Sleeve are ground. For balanced inputs, Tip and Ring are signal; Sleeve is ground (Paragraph 3-162). Input impedance is 1 megohm, 40 pF for Unbalanced input, approximately 15 K for Balanced Bridged input and 600 Ω or 900 Ω (Calibration switch) for Balanced Terminated input (Paragraph 3-156).
- 15 INPUT Mode Switch (3581C only): Selects Unbalanced, Balanced Bridged or Balanced Terminated input. (Paragraph 3-158)
- 16 UNCAL Indicator: Lights when Amplitude VERNIER is not in the CAL position -- scales no longer calibrated for absolute measurements. (Paragraph 3-34)
- 17 Amplitude VERNIER: For absolute measurements, VERNIER must be set to CAL (fully CW) position. For relative measurements, VERNIER adjusts gain of analyzer to establish full-scale reference. As the VERNIER is rotated counterclockwise, the gain decreases and the full-scale input level increases. (Paragraphs 3-33, 3-38)
- 18 INPUT SENSITIVITY Switch: Selects maximum (full-scale) input level and measurement range. For absolute measurements, full-scale settings range from +30 dB/30 V to -70 dB/0.3 mV (Paragraphs 3-56, 3-65). For measurements using the Volts scale, 7 additional ranges can be selected using the AMPLITUDE REF LEVEL switch (Paragraph 3-62). With the switch in the CAL position, the INPUT is disconnected and an internal calibration signal is applied to the input circuits (Paragraph 3-77).
- 19 CAL 10 kHz Potentiometer: Adjust for full-scale deflection using internal calibration signal (Paragraph 3-173). Adjustment compensates for variations in amplitude accuracy that occur when control settings are changed or when instrument is operated in uncontrolled environment (Paragraph 3-78).
- 20 Calibration Switch:
 3581A: Set to dBV/LIN position for absolute measurements in dBV or rms volts or for relative measurements in dB or percent of full scale. Set to dBm/600 Ω position for absolute measurements in dBm/600 ohms (external termination required) or for relative measurements in dB. (Paragraph 3-32)

 3581C: Set to dBm 900 Ω/LIN position for absolute measurements in dBm/ 900 ohms or rms volts or for relative measurements in dB or percent of full scale. Set to dBm/600 Ω position for absolute measurements in dBm/600 ohms or for relative measurements in dB (Paragraph 3-32). Switch selects 900 Ω or 600 Ω input impedance for Balanced Terminated input (Paragraph 3-161).
- 21 AMPLITUDE REF LEVEL Switch: Operates in conjunction with INPUT SENSITIVITY switch to establish the full-scale sensitivity and measurement range. (Paragraphs 3-58, 3-69, 3-71)
- 22 AFC Button: Push to set (AFC on) push to release (AFC off). (Paragraph 3-99)
- 23 Meter Mechanical Zero: Paragraph 3-171.
- 24 POWER Switch: Applies line voltage to instrument when set to ON (AC) position; applies battery power to Option 001 instruments when set to ON (BAT) position; applies line voltage to Option 001 instruments to recharge batteries when set to CHARGE position. (Paragraph 3-168)
- 25 Log 10 dB SCALE Button: Selects 0 dB to -10 dB meter scale. Display sensitivity is 1 dB/div., display range is 10 dB. Any 10 dB portion of 80 dB range can be selected using AMPLITUDE REF LEVEL switch. (Paragraph 3-71)
- 26 Log 90 dB SCALE Button: Selects 0 dB to -90 dB meter scale for absolute measurements in dBV/dBm or relative measurements in dB. Dynamic range is 80 dB. (Paragraph 3-67)
- 27 VOLTS SCALE Button: Selects linear amplitude mode for absolute measurements in rms volts or relative measurements in percent of full scale. (Paragraph 3-56)
- 28 POWER Light: Lights when POWER switch is set to ON (AC), ON (BAT) or CHARGE.

Figure 3-1. Front Panel (cont'd).

3-8. GENERAL OPERATING INFORMATION.

3-9. Input Connections (3581A only).

3581C: Refer to Paragraph 3-156.

3-10. The 3581A has two INPUT terminals. The upper (red rimmed) terminal is the signal input and the lower (black rimmed) terminal is case ground. The plastic caps on the terminals unscrew to permit wire connections and the terminals are spaced so that they will accept a dual banana-plug mating connector. The input signal can be applied to the 3581A through a twisted pair, a shielded cable equipped with banana-plug connectors (-hp- 11000A Cable Assy.) or a 10:1 Voltage Divider Probe (-hp-10004B). Input leads should be kept as short as possible to minimize extraneous pickup. If a 10:1 Voltage Divider Probe is to be used, connect it to the INPUT using a BNC to banana-plug adapter (-hp- Part No. 1251-2277). Before using the probe, perform the Input Probe Compensation procedure outlined in Paragraph 3-176.

3-11. Input Impedance.

3-12. The 3581A has a single-ended input which provides an input impedance of 1 megohm shunted by < 30 pF (28 pF nominal). The 3581C has three selectable input configurations: Unbalanced, Balanced Bridged and Balanced Terminated. The Unbalanced configuration provides an input impedance of 1 megohm shunted by 40 pF (nominal). The Balanced Bridged input impedance is approximately 15 kilohms and the Balanced Terminated input impedance is 600 ohms or 900 ohms. The terminated input impedance is selected by the front panel Calibration switch (Item 20, Figure 3-1). Refer to Paragraph 3-158 for further information concerning the 3581C input configurations.

3-13. Figure 3-3 shows the equivalent circuit for the 3581A single-ended input. The resistor, R_{in} , represents the 1 megohm input resistance and the capacitor, C_s , represents the 28 pF shunt capacitance. Figure 3-4 is a graph showing the input impedance, Z_t , as a function of frequency. At low

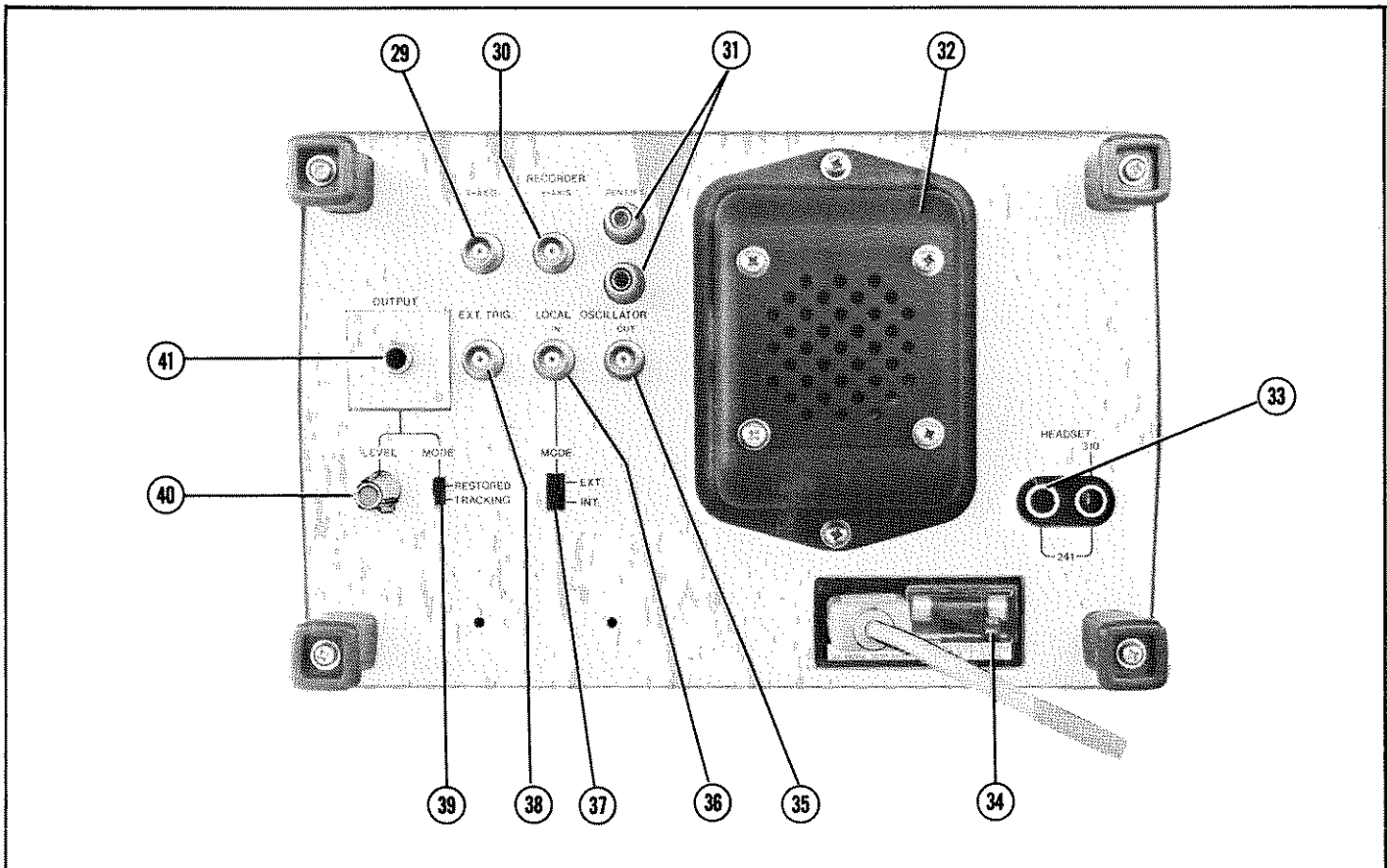

- 29** X-AXIS Output: Female BNC connector supplies dc voltage proportional to frequency sweep. Output ranges from 0 V (start frequency) to +5 V (end frequency) Output resistance is 1 kilohm, nominal. (Paragraph 3-135)
- 30** Y-AXIS Output: Female BNC connector supplies dc voltage proportional to meter reading. Output ranges from 0 V to +5 V dc full scale. Output resistance is 1 kilohm, nominal. (Paragraph 3-137)
- 31** PEN-LIFT Output. For X-Y recorders having remote controlled penlift. A contact closure is present across PEN-LIFT terminals during single and repetitive sweeps. Contacts open before sweep resets and close after sweep resets to prevent retrace. (Paragraph 3-138)
- 32** Speaker for Audio Monitor (3581C only).
- 33** HEADSET Connector (3581C only): Supplies audio output for headphone. Accepts WECO Type 310 or Type 241 mating plug. (Paragraph 3-164)
- 34** Power Input Module: Accepts power cord supplied with instrument. Contains line fuse and PC board for selecting line voltage. (Paragraph 3-168)
- 35** LOCAL OSCILLATOR OUT. Female BNC connector supplies 100 mV rms, 1 MHz to 1.5 MHz signal that tracks the tuned or swept frequency of the instrument. Output impedance is 1 kilohm, nominal. (Paragraph 3-144)
- 36** LOCAL OSCILLATOR IN Connector. Female BNC connector. Analyzer can be remotely tuned by applying an externally generated 1 MHz to 1.5 MHz signal to this connector. (Paragraph 3-148)
- 37** MODE Switch. Selects Internal (INT) or External (EXT) local oscillator. External L.O. signal is applied to LOCAL OSCILLATOR IN connector.
- 38** EXT TRIG Input: Female BNC connector. Apply contact closure or TTL output to remotely trigger the frequency sweep. (Paragraph 3-129)
- 39** Output MODE Switch: Selects TRACKING OSC. or RESTORED output for OUTPUT connector.
- 40** LEVEL control. Adjusts amplitude of OUTPUT signal.
- 41** OUTPUT Connector:
 3581A: Female BNC connector supplies 5 Hz to 50 kHz signal that tracks the tuned or swept frequency of the instrument. With Output MODE switch set to TRACKING OSC position, output level is constant. With switch set to RESTORED position, output level is proportional to amplitude of signal being measured. Output level can be adjusted from 0 V to 2 V rms (open circuit) using rear panel LEVEL control. Output impedance is 600 ohms, unbalanced. (Paragraph 3-139)
- 3581C: Accepts WECO Type 310 (or equiv.) mating plug. Balanced output supplies 15 Hz to 50 kHz signal that tracks tuned or swept frequency of the instrument. With Output MODE switch set to RESTORED position, output level is proportional to amplitude of signal being measured. Output level can be adjusted from 0 V to 2 V rms (open circuit) using rear panel LEVEL control. Output impedance is 600 ohms. (Paragraphs 3-139, 3-163)

Figure 3-2. Rear Panel.

frequencies the reactance of C_s is very high making Z_t nearly equal to R_{in} . As frequency increases, the decreasing reactance of C_s becomes more and more significant, causing Z_t to decrease. At 50 kHz, Z_t is approximately 100 kilohms.

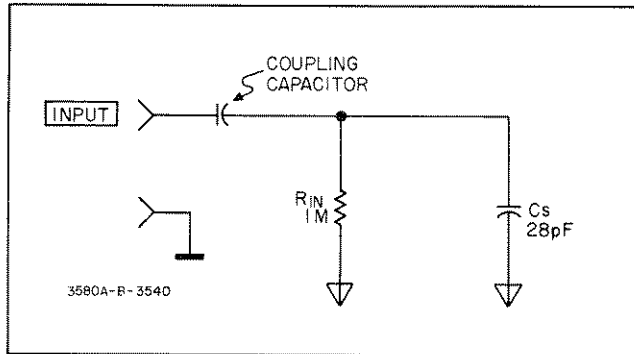

Figure 3-3. Equivalent Input Circuit.

3-14. Input Constraints.



The information given in Paragraphs 3-15 and 3-16 applies to the 3581C only when it is operated with the UNBALANCED or BALANCED BRIDGED input configuration. Refer to Paragraph 3-161 for special information concerning the Balanced - Terminated input configuration.

3-15. The maximum ac voltage that can be safely applied to the 3581A INPUT is determined by the INPUT SENSITIVITY switch setting (Paragraph 3-38). Maximum input levels are listed in Table 3-3. The 3581A input

circuits are well protected and can withstand momentary (< 5 second) overloads up to 100 V rms on all input ranges. The instrument can withstand continuous overloads up to 100 V rms on the + 30 dB through - 10 dB ranges and overloads up to 50 V rms on the - 20 dB through - 70 dB ranges. Overloads greater than this may damage the instrument.



Input levels exceeding 100 V rms on the + 30 dB through - 10 dB ranges, 50 V rms on the - 20 dB through - 70 dB range or ± 100 V dc may damage the instrument.

3-16. DC Isolation. The 3581A input and the 3581C unbalanced and bridged inputs are capacitively coupled to provide dc isolation. The maximum dc voltage that can be safely applied to the INPUT is ± 100 V dc. Voltage levels exceeding this limit can cause breakdown of the coupling capacitor resulting in damage to the input circuitry.

3-17. The 3581A cannot be operated in a floating condition. All input and output commons are connected directly to outer-chassis (frame) ground which connects to earth ground through the offset pin of the power-cord connector. The 3581C balanced inputs and balanced tracking oscillator output are isolated from outer-chassis ground.

3-18. Grounding.

3-19. To protect operating personnel, the 3581A/C chassis must be grounded. The 3581A/C is equipped with a three-conductor power cord which, when plugged into an appropriate receptacle, grounds the instrument. The offset pin on the power plug is the ground connection.

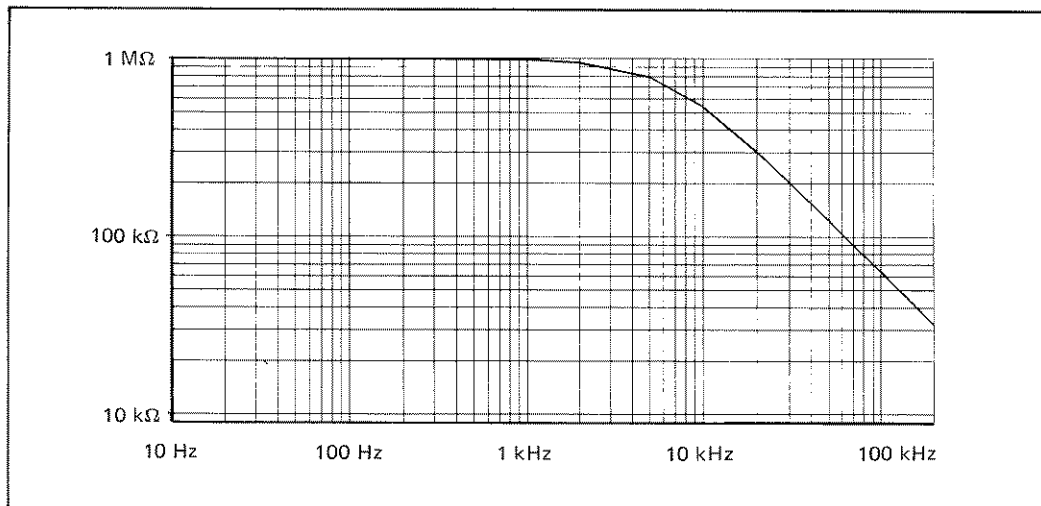

Figure 3-4. Graph Z_t vs. Frequency.

3-20. To preserve the protection feature when operating the instrument from a two-contact outlet, use a three-prong to two-prong adapter and connect the lead on the adapter to earth ground.

3-21. For battery powered instruments (Option 001), the common binding post (or 3581C Sleeve) of the INPUT connector should be connected to earth ground or to an appropriate system ground. *If a system ground is used, be sure it is at earth ground potential and is not a voltage source.*

3-22. Ground Loops.

3-23. In the design of the 3581, extra care has been taken to control internal ground currents that could produce undesirable responses or degrade the accuracy of low level measurements. Due to its wide dynamic range and high sensitivity, however, the 3581 can be affected by external ground currents or "ground loops" which are normally caused by poor grounding. The following paragraphs briefly describe the common power-line ground loop and outline the steps that can be taken to minimize ground loop problems.

3-24. Figure 3-5A shows the input arrangement for a simple grounded measurement. E_{in} represents the source being measured along with any noise associated with it and is generally called the "normal-mode source". R_s represents the source resistance and the resistance of the high lead; R_g represents the resistance of the ground lead. Current from E_{in} (normal-mode current) flows through R_s , Z_1 and R_g and the instrument responds to the drop across Z_1 . As long as the grounds on both sides of R_g are identical, extraneous currents cannot circulate between the source ground and

the instrument ground. If, however, the grounds are different due to voltage drops in the ground lead or currents induced into it, a new source is developed and the measurement appears as shown in Figure 3-5B. The new source, E_{cm} (the difference between grounds), is called the "common-mode source" because it is common to both the high and ground lines. Common-mode current can flow through R_g or through R_s and Z_1 . Since Z_1 is usually much larger than R_s and since they are both in parallel with R_g , most of the voltage across R_g will appear across Z_1 causing an error in the amplitude reading.

3-25. To minimize power-line ground loops, the following guidelines should be observed:

- a. Keep input leads as short as possible.
- b. Provide good ground connections to minimize R_g .
- c. Connect the signal source and the 3581 to the same power bus.
- d. If a removable ground strap is provided on the signal source, float the source to break the common-mode current path.
- e. Option 001: Battery operate the 3581; connect a separate ground lead between the common terminal of the 3581 INPUT connector and the ground terminal of the signal source.
- f. 3581C: Use balanced inputs.

3-26. Measurement Configurations.

3-27. The 3581 can be used in either of two measurement configurations: open loop or closed loop. These configurations are illustrated in Figure 3-6.

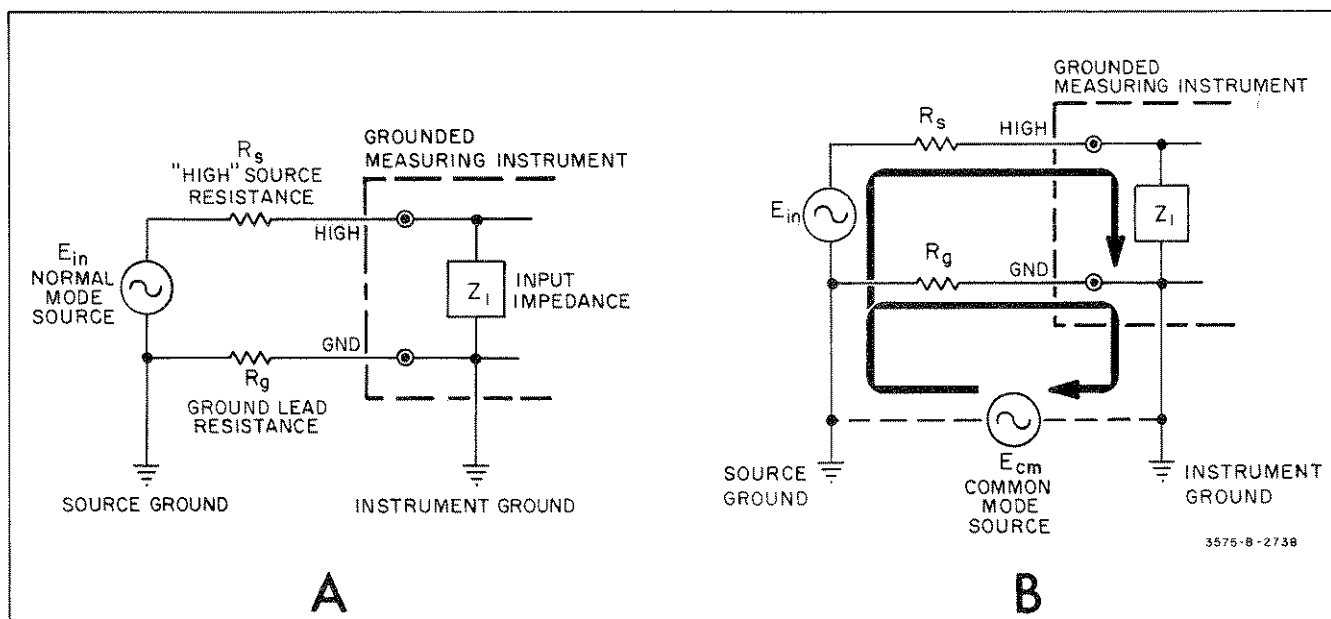

Figure 3-5. Power Line Ground Loop.

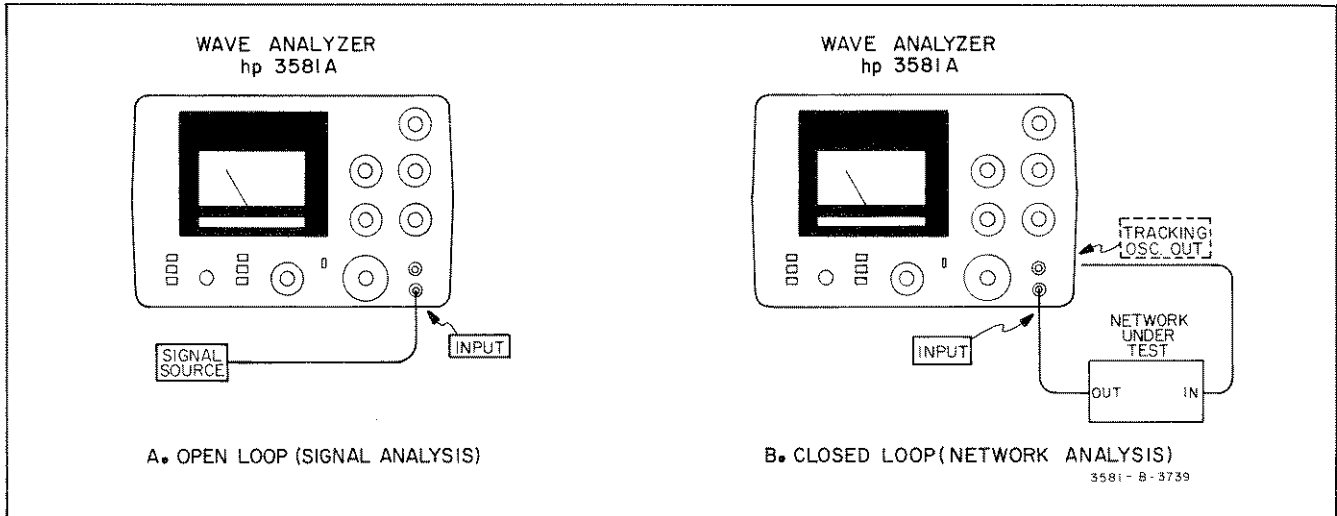

Figure 3-6. Measurement Configurations.

3-28. Open Loop. In the open loop configuration, the 3581 functions as a *signal analyzer* or “selective voltmeter” which divides the input signal into its various frequency components. The amplitudes and frequencies of these components can be measured by manually tuning the analyzer to specific frequencies or by sweeping the analyzer over a given range. For swept measurements, an X–Y recorder or variable persistence (storage) scope can be connected to the rear panel Recorder outputs to provide an amplitude vs. frequency display. The amplitude vs. frequency display shows how energy is distributed as a function of frequency and, in effect, is the Fourier spectrum of the input signal (Figure 3-7). Some of the more common measurements that can be made using the open-loop configuration include harmonic distortion, intermodulation distortion, spurious, square-wave symmetry and noise.

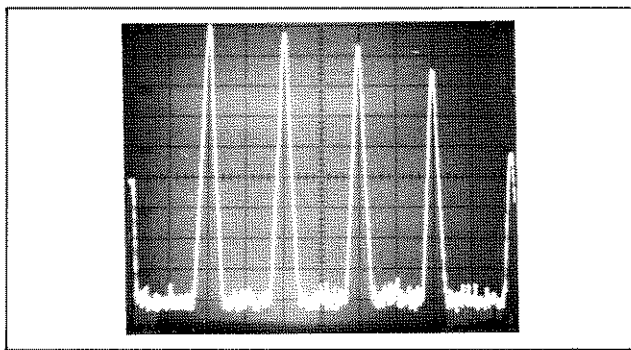

Figure 3-7. Spectral Display (10 kHz Pulse Train).

3-29. Closed Loop. In the closed-loop configuration, the 3581 functions as a *network analyzer* for characterizing two-port devices such as amplifiers, attenuators and filters. For closed-loop measurements, the network to be tested is inserted between the rear panel Tracking Oscillator Output and the front panel Input. The Tracking Oscillator Output supplies a fixed level, 5 Hz to 50 kHz signal which tracks the tuned frequency of the instrument. This signal serves as

a stimulus for the network under test. As the frequency is manually tuned or swept over a given range, the amplitude of the signal at the output of the network varies according to the response characteristics of the network. These amplitude variations are measured by the 3581 and, when displayed in graphical form, yield an amplitude vs. frequency plot of the network (Figure 3-8).

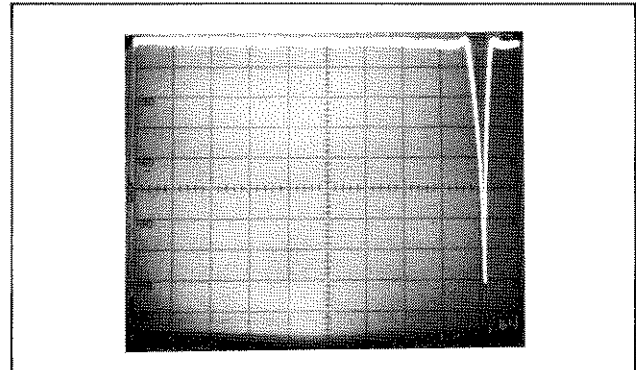

Figure 3-8. Amplitude vs. Frequency Plot of Notch Filter.

3-30. One method for making closed-loop measurements is to manually vary the frequency and plot a response curve point-by-point on graph paper. This method, however, is tedious, time consuming and often inaccurate since it is easy to miss important points. A faster, more accurate method is to sweep the frequency over the band of interest and display the response curve using a scope or X–Y recorder. Swept measurements provide a continual updating or “refreshing” of information. This makes it possible to adjust the network while observing the results of the adjustment.

3-31. Absolute/Relative Measurements.

3-32. Absolute Measurements. Absolute measurements are used to determine the actual amplitudes of tuned signals. The 3581A can be calibrated for absolute measurements in

Table 3-2. Calibration Charts

3581A CALIBRATION CHART			3581C CALIBRATION CHART				
Calibration Switch	Scale Buttons	Single-Ended Input	Calibration Switch	Scale Buttons	INPUT		
					Unbalanced	Bridged	Terminated
dBV/LIN	VOLTS	Input impedance 1 MΩ, 30 pF. No termination required. Read volts on voltage scales of meter. Input of 1 V rms gives 1 V meter reading.	dBm 900 Ω/LIN	VOLTS	Input impedance 1 MΩ, 40 pF. Read volts on voltage scales of meter. Input of 1 V rms gives 1 V meter reading.	Input impedance 15 K. Read volts on voltage scales of meter. Input of 1 V rms gives 1 V meter reading.	Input impedance 900 Ω. Read volts on voltage scales of meter. Input of 1 V rms gives 1 V meter reading.
	dB	Input impedance 1 MΩ, 30 pF. No termination required. Read dBV on dB meter scales. Input of 1 V rms gives 0 dBV meter reading.			Input impedance 15 K. External 900 Ω termination needed for 900 Ω source. Read dBm/900 Ω on dB meter scales. Input of 0.949 V rms gives 0 dBm meter reading.	Input impedance 900 Ω. Read dBm/900 Ω on dB meter scales. Input of 0.949 V rms gives 0 dBm meter reading.	
	VOLTS	Not a valid combination. Scales not calibrated.			Not a valid combination. Scales not calibrated.	Not a valid combination. Scales not calibrated.	
dBm 600 Ω	VOLTS	Not a valid combination. Scales not calibrated.	dBm 600 Ω	VOLTS	Not a valid combination. Scales not calibrated.	Not a valid combination. Scales not calibrated.	Not a valid combination. Scales not calibrated.
	dB	Input impedance 1 MΩ, 30 pF. External 600 Ω termination needed for 600 Ω source. Read dBm/600 Ω on dB meter scales. Input of 0.775 V rms gives 0 dBm meter reading.			Input impedance 1 MΩ, 40 pF. External 600 Ω termination needed for 600 Ω source. Read dBm/600 Ω on dB meter scales. Input of 0.775 V rms gives 0 dBm meter reading.	Input impedance 15 K. External 600 Ω termination needed for 600 Ω source. Read dBm/600 Ω on dB meter scales. Input of 0.775 V rms gives 0 dBm meter reading.	Input impedance 900 Ω. Read dBm/600 Ω on dB meter scales. Input of 0.775 V rms gives 0 dBm meter reading.

* NOTE: The 3581A has no provision for dBm/900 Ω measurements. There is no internal termination for any switch setting.

rms volts, dBV or dBm/600 ohms. The 3581C can be calibrated for absolute measurements in rms volts, dBm/900 ohms or dBm/600 ohms. Control settings, termination requirements and other details concerning these measurements are given in Table 3-2. For all absolute measurements, the front panel amplitude VERNIER control must be set to the CAL position and the instrument must be calibrated as outlined in Paragraph 3-173.

3-33. Relative Measurements. In signal analysis, relative measurements are used for comparing the amplitudes of two or more frequency components of a signal. In network analysis, relative measurements are used for comparing the amplitude variations of a response curve at two or more frequencies. Relative measurements do not require a calibrated scale; that is, using the amplitude VERNIER and other amplitude controls, the gain of the analyzer can be adjusted so that any input level within the range of 100 V rms to 0.1 μV rms will produce full-scale meter deflection. This arbitrary full-scale input level then serves as a reference for measuring signals that are lower in amplitude. When the linear scale is used, relative measurements are expressed in "percent of full scale". When the log scales are used, relative measurements are expressed in dB below a 0 dB reference level.

3-34. Uncal. Indicator.

3-35. As previously stated, the front panel amplitude VERNIER control must be in the CAL position for all absolute measurements. When the VERNIER is not in the CAL position, the front panel UNCAL indicator lights to indicate that the meter scales are no longer calibrated in rms volts, dBV or dBm.

3-36. Overload Indicator.

3-37. Figure 3-9 is a simplified block diagram showing the 3581 Input Section. The INPUT SENSITIVITY switch and its associated VERNIER potentiometer controls the input attenuation and gain of the Input circuits to maintain the proper signal level at the input of the Mixer. This is an important function since signals that overdrive the Mixer can produce harmonic and spurious mixing products which result in erroneous meter readings. The Overload Detector

at the input of the Mixer senses when the signal level exceeds the design limits and, in turn, lights the front panel OVERLOAD indicator. As previously indicated, the 3581 input circuits are well protected and can withstand momentary overloads up to 100 V rms on all ranges. In most cases, an OVERLOAD indication simply means that the input signal is overdriving the Input Circuits or the Mixer and harmonic and spurious responses may be present. Generally, any time the OVERLOAD light is off the instrument-induced distortion and spurious is more than 80 dB below the full-scale reference level.

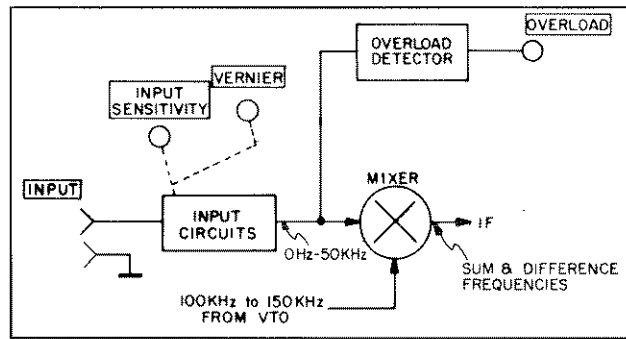

Figure 3-9. Input Section.

3-38. Maximum Input Level.

3-39. The *maximum input level* is the maximum level that can be applied to the INPUT without overloading the instrument. The maximum input level is determined only by the INPUT SENSITIVITY and amplitude VERNIER settings and is *not* affected by the AMPLITUDE REF LEVEL setting. With the amplitude VERNIER in the CAL position, the maximum input level is indicated by a black panel index adjoining the INPUT SENSITIVITY switch dial and the OVERLOAD indicator (Figure 3-10). For the Log scale settings, the maximum input level is defined by the black (dB) markings on the INPUT SENSITIVITY switch dial. For the 3581A, these markings represent dBV or dBm/600 ohms. For the 3581C, the markings represent dBm/900 ohms or dBm/600 ohms. The maximum input level for the Volts scale setting is indicated by the blue

Table 3-3. Maximum Input Levels.

INPUT SENSITIVITY SETTING	(VERNIER in CAL)		(VERNIER fully CCW)		POTENTIAL DAMAGE LEVEL (Continuous Overload)
	LINEAR MODE	LOG MODE	LINEAR MODE	LOG MODE	
+ 30 dB/30 V	32 V	+ 30 dBV/dBm	100 V*	+ 40 dBV/dBm	100 V*
+ 20 dB/10 V	10 V	+ 20 dBV/dBm	32 V	+ 30 dBV/dBm	
+ 10 dB/3 V	3.2 V	+ 10 dBV/dBm	10 V	+ 20 dBV/dBm	
0 dB/1 V	1 V	0 dBV/dBm	3.2 V	+ 10 dBV/dBm	100 V
- 10 dB/0.3 V	0.32 V	- 10 dBV/dBm	1 V	0 dBV/dBm	
- 20 dB/0.1 V	0.1 V	- 20 dBV/dBm	0.32 V	- 10 dBV/dBm	
- 30 dB/30 mV	32 mV	- 30 dBV/dBm	0.1 V	- 20 dBV/dBm	50 V
- 40 dB/10 mV	10 mV	- 40 dBV/dBm	32 mV	- 30 dBV/dBm	
- 50 dB/3 mV	3.2 mV	- 50 dBV/dBm	10 mV	- 40 dBV/dBm	
- 60 dB/1 mV	1 mV	- 60 dBV/dBm	3.2 mV	- 50 dBV/dBm	50 V
- 70 dB/0.3 mV	0.32 mV	- 70 dBV/dBm	1 mV	- 60 dBV/dBm	



The differential signal level applied to the 3581C BALANCED-TERMINATED input must not exceed + 27 dBm at 0 V dc (Paragraph 3-161).

*Absolute maximum input voltage for 3581A and 3581C unbalanced and bridged inputs.

(volts) markings on the INPUT SENSITIVITY switch dial. Note that the maximum input levels for the 30 V, 3 V, 0.3 V, etc. ranges are actually 32 V, 3.2 V and 0.32 V, corresponding to full-scale meter deflection. When the amplitude VERNIER is rotated counterclockwise away from the CAL position, the gain of the Input Circuit decreases, the maximum input level increases and the markings on the INPUT SENSITIVITY switch dial no longer apply. Table 3-3 lists the maximum input levels for each INPUT SENSITIVITY setting with the amplitude VERNIER in the CAL and fully counterclockwise positions. Observing these maximum input levels will ensure optimum performance on all ranges.

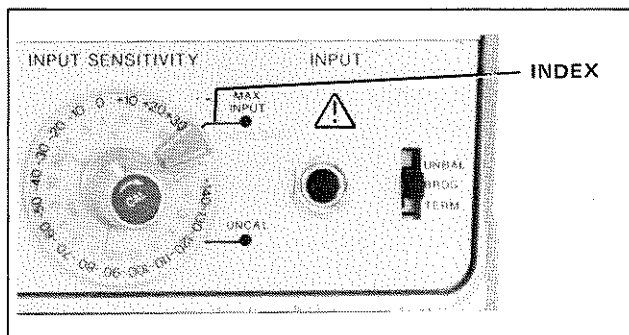

Figure 3-10. Maximum Input Index.

3-40. Sensitivity.

3-41. Maximum Sensitivity. Maximum Sensitivity refers to the smallest signal that can be detected by the analyzer. The maximum sensitivity of the analyzer is limited by its own internally generated noise and is commonly defined as the point where the signal level is equal to the noise level. This is sometimes called "tangential sensitivity".

$$E_n = (4 kTBR)^{1/2}$$

Where E_n = noise level; k = Boltzmann's constant; T = temperature ($^{\circ}$ K); B = bandwidth (Hz); R = input resistance.

3-42. Nyquist's Noise Equation¹ reveals two important things about noise that apply to the 3581:

a. Noise is proportional to the square root of bandwidth... Noise level decreases and sensitivity increases as the BANDWIDTH setting is narrowed.

b. Noise is proportional to the square root of input resistance... The 3581 has a high (1 megohm) input resistance. This means that noise is largely dependent on the source resistance placed at the INPUT terminals. Signal sources having low output resistances will produce a lower noise level than those having high output resistances.

3-43. Noise level is also dependent on the tuned frequency of the instrument. Semiconductors in the input stages of the instrument exhibit surface noise which has a 1/f frequency spectrum. This surface noise is predominate at frequencies below 1 kHz. When the 3581 is tuned below 1 kHz, the noise level increases and sensitivity decreases.

3-44. Figure 3-11 is a family of curves showing the specified noise levels vs. frequency for the 300 Hz, 30 Hz and 3 Hz BANDWIDTH settings. Typically, if the source resistance is less than 10 kilohms, the noise levels will be below those indicated by the curves.

3-45. Full Scale Sensitivity. Full scale sensitivity defines the input level that will produce full scale deflection on any given range. For absolute measurements, full scale sensitivity ranges from 30 V rms to 0.1 μ V rms in the Linear mode and from + 30 dBV/dBm to - 140 dBV/dBm in the Log (90 dB) mode. With the amplitude VERNIER control set fully counterclockwise, full scale sensitivity ranges from approximately 100 V rms to 0.3 μ V rms in the Linear mode

and from +40 dBV/dBm to -130 dBV/dBm in the Log mode.

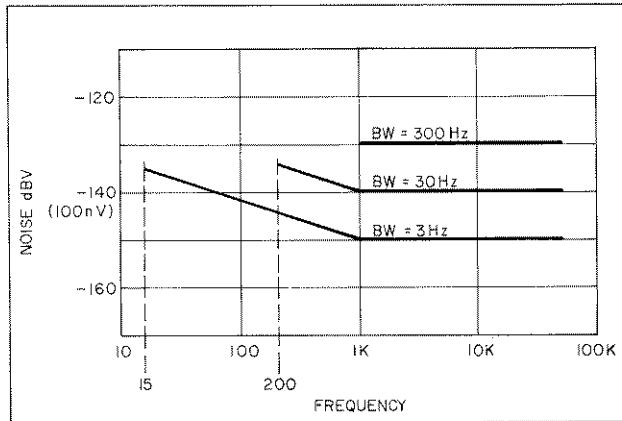

Figure 3-11. Noise vs. Frequency.

3-46. Dynamic Range.

3-47. For operating purposes, the dynamic range of a wave analyzer can be defined as the ratio of the largest to smallest signals it can measure for a given range setting. The largest signal that can be measured (full-scale sensitivity) is determined by the INPUT SENSITIVITY, amplitude VERNIER and AMPLITUDE REF LEVEL settings. The smallest signal that can be measured is determined by:

- instrument-induced distortion and spurious
- display range
- internal noise floor (maximum sensitivity)

3-48. **Distortion and Spurious.** When the OVERLOAD light is off, the instrument-induced distortion and spurious is more than 80 dB below full scale.

3-49. **Display Range and Noise Floor.** When the volts scale is selected, the smallest signal that can be measured is approximately 10% of full scale. Thus, the dynamic range is about 20 dB as long as the noise floor is more than 20 dB below full scale. When the Log 90 dB scale is selected, displayed readings of less than -80 dB are not specified. The dynamic range is 80 dB as long as the noise floor is more than 80 dB below full scale. When the Log 10 dB scale is selected, the dynamic range is 10 dB as limited by the display range.

3-50. Meter Scales.

3-51. Refer to Figure 3-12 for the following discussion. The 3581 SCALE buttons permit selection of three scale settings: Volts (linear), Log 90 dB and Log 10 dB.

3-52. **Voltage Scales.** When the Volts SCALE button is pressed and the amplitude VERNIER is in the CAL

position, the meter indicates signal amplitude in rms volts (average responding). There are two voltage scales on the meter. These are scales C and D. Scale C ranges from 0 to 1 and scale D ranges from 0 to 3.2. The full-scale sensitivity is indicated by the white window on the INPUT SENSITIVITY switch dial. If the full-scale sensitivity is 10 V, 1 V, 0.1 V, etc., read the meter using scale C. If the full-scale sensitivity is 30 V, 3 V, 0.3 V, etc., read the meter using scale D. Refer to Paragraph 3-56 for further information concerning the use of the linear scales.

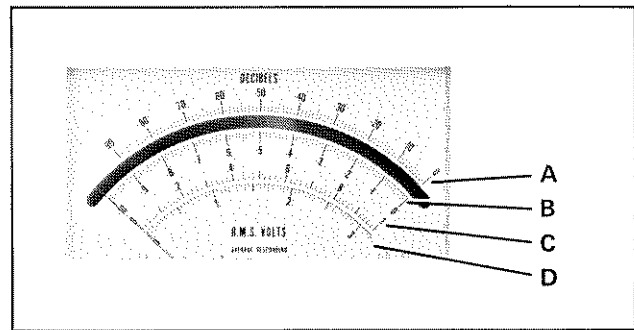

Figure 3-12. Meter Scales.

3-53. **Log Scales.** When the Log 90 dB or Log 10 dB SCALE button is pressed and the amplitude VERNIER is in the CAL position, the meter indicates signal amplitude in dBV or dBm as selected by the front panel Calibration switch. When the VERNIER is not in the CAL position, the meter indicates relative amplitude in dB.

3-54. There are two logarithmic scales on the meter. These are scales A and B. When the Log 90 dB SCALE button is pressed, the meter can be read using scale A which ranges from 0 dB to -90 dB. For absolute measurements, a reading of 0 dB corresponds to the full-scale reference indicated by the white window on the INPUT SENSITIVITY switch dial. The absolute signal level is the algebraic sum of the full-scale reference and the meter reading. For example, if the full-scale reference is -40 dB and the meter reading is 0 dB, the signal amplitude is -40 dBV or dBm. Similarly, if the full-scale reference is -20 dB and the meter reading is -40 dB, the signal amplitude is -60 dBV or dBm.

3-55. When the Log 10 dB SCALE button is pressed, the meter scale is expanded to 1 dB per division over a 10 dB range. The meter can then be read using scale B which ranges from 0 dB to -10 dB. The Log 10 dB scale can be read in the same manner as the Log 90 dB scale. A reading of 0 dB corresponds to the full-scale reference indicated on the INPUT SENSITIVITY switch dial. The full-scale reference can be adjusted from 0 dB to -70 dB using the AMPLITUDE REF LEVEL switch. The absolute signal level is the algebraic sum of the full-scale reference and the meter reading. Refer to Paragraph 3-65 for further information concerning the use of the log scales.

3-56. Using the Linear (Volts) Scales.

3-57. For amplitude measurements using the linear scales, the full-scale sensitivity is determined by the INPUT

SENSITIVITY and AMPLITUDE REF LEVEL switch settings. The INPUT SENSITIVITY switch controls the input attenuation and gain of the input circuits to establish the maximum input level as outlined in Paragraph 3-37. The AMPLITUDE REF LEVEL switch controls an IF attenuator which determines the gain of the IF Amplifier and the meter sensitivity. As the AMPLITUDE REF LEVEL switch is rotated in a clockwise direction, the IF attenuation decreases, the IF gain increases and the full-scale sensitivity increases.

3-58. By observing the INPUT SENSITIVITY and AMPLITUDE REF LEVEL controls, it can be noted that the full scale (blue) markings on the INPUT SENSITIVITY switch dial are indicated by a white window that is mechanically linked to the AMPLITUDE REF LEVEL switch. Changing the position of either switch changes the full-scale sensitivity in a 30 V, 10 V, 3 V, 1 V sequence. Changing the INPUT SENSITIVITY switch setting changes the maximum input level *and* the full-scale sensitivity. Changing the AMPLITUDE REF LEVEL switch setting changes the full-scale sensitivity but does *not* effect the maximum input level. For example, if the INPUT SENSITIVITY switch is set for a maximum input of 1 V rms, and the AMPLITUDE REF LEVEL switch is set to the X0.1 position, the full-scale sensitivity is 0.1 V rms but the maximum input level is still 1 V rms. Signals between 0.1 V rms and 1 V rms will overdrive the meter but will not damage the instrument or hinder its ability to measure signals within the 0 V to 0.1 V range.

NOTE

When using the linear (Voltage) scales, be sure the Calibration switch is set to the dBV/LIN (3581A) or dBm 900Ω/LIN (3581C) position.

3-59. Relative Measurements (Linear Scale). For relative measurements using the linear scale, the INPUT SENSITIVITY and amplitude VERNIER controls are adjusted so that the reference signal produces full-scale deflection on the 0 to 1 meter scale. Whenever possible, this should be done with the AMPLITUDE REF LEVEL switch set to the X1 position. Signals below the reference level are then measured in "percent of full scale" where the reference is 100% and each major division of the 0 to 1 meter scale is 10%. Signals below 30% of full scale can be measured on an expanded scale by changing the AMPLITUDE REF LEVEL setting. With the AMPLITUDE REF LEVEL switch set to the first unmarked position between X1 and X0.1, the meter range is from 0 to 32% and the meter can be read using the 0 to 3 scale. A reading of "3" corresponds to 30%. With the AMPLITUDE REF LEVEL switch set to the X0.1 position, the meter range is from 0 to 10% and the meter can be read using the 0 to 1 scale. As the AMPLITUDE REF LEVEL switch is rotated further clockwise, the ranging sequence is 3%, 1%, 0.3% and 0.1%. The 0 to 1 meter scale can be read for the 100%, 10%, 1% and 0.1% ranges and the 0 to 3 scale can be read for the 30%, 3% and 0.3% ranges.

3-60. If, when measuring low-level signals, a full-scale reference cannot be obtained with the AMPLITUDE REF LEVEL switch in the X1 position, a lower setting can be used. The setting on which the full-scale reference is obtained becomes the 100% range and the lower settings become the 30%, 10%, 1%, etc. ranges.

3-61. **Alternative Method.** Another method for determining the relative amplitude of two signals is to first measure the absolute voltage levels and then calculate their relative amplitude using the following formula:

$$A = \frac{V_2}{V_1} \times 100$$

Where:

- A = relative amplitude in percent
- V1 = reference level in rms volts
- V2 = signal level in rms volts

3-62. Using the Amplitude Ref. Level Control. Whenever possible, the AMPLITUDE REF LEVEL switch should be left in the NORMAL (X1) position and the INPUT SENSITIVITY switch should be used to set the full-scale sensitivity. This is because the Amplitude Calibration Procedure (Paragraph 3-173) is performed with the AMPLITUDE REF LEVEL switch in the NORMAL position and any error introduced by the IF Attenuator is adjusted out. When the AMPLITUDE REF LEVEL setting is changed from the NORMAL position, the accuracy of the IF Attenuator must be considered. This means that a possible worst-case error of $\pm 3\%$ of full scale must be *added* to the amplitude accuracy specification. Amplitude accuracy is discussed in Paragraph 3-72.

3-63. The INPUT SENSITIVITY and AMPLITUDE REF LEVEL controls provide a total of 18 voltage ranges (30 V to 0.1 μ V). The top 11 ranges can be selected using the INPUT SENSITIVITY switch with the AMPLITUDE REF LEVEL switch set to the NORMAL position. The seven bottom ranges can be selected using the AMPLITUDE REF LEVEL control with the INPUT SENSITIVITY switch set to the 0.3 mV (full CW) position.

3-64. The AMPLITUDE REF LEVEL switch can also be used for expanded scale measurements where the input level is 0.3 mV rms or greater and the components to be measured are less than 30% of full scale. In this case, the AMPLITUDE REF LEVEL switch should initially be set to the X1 position and the INPUT SENSITIVITY switch set to the lowest range that does not produce an OVERLOAD indication. The AMPLITUDE REF LEVEL control can then be adjusted so that the low level signals of interest can be measured.

3-65. Using the Log Scales.

3-66. The 3581A log scales can be used for absolute measurements in dBV (1 V rms = 0 dBV) or dBm/600 ohms

or for relative measurements in dB. The 3581C log scales can be used for absolute measurements in dBm/900 ohms or dBm/600 ohms or for relative measurements in dB. For absolute measurements, the unit of measure (dBV, dBm/600 Ω , dBm/900 Ω) is determined by the position of the front panel Calibration switch.

3-67. When the Log 90 dB scale is selected, the dynamic range of the meter scale is 90 dB although the specified dynamic range of the instrument is 80 dB. The region between -80 dB and -90 dB is useful for detecting the presence of low-level signals but should not be used for measurements.

3-68. With a dynamic range of 80 dB, only eleven full-scale ranges are needed to cover the full measurement range of the instrument. These eleven ranges are selected using the INPUT SENSITIVITY switch. For absolute measurements, the full-scale sensitivity ranges from +30 dBV/dBm to -70 dBV/dBm.

3-69. The maximum input level for the log scales is determined by the INPUT SENSITIVITY and amplitude VERNIER settings. For absolute measurements, the full-scale sensitivity is indicated by the white window on the INPUT SENSITIVITY switch dial. The log scales, however, do not require an IF attenuator and the AMPLITUDE REF LEVEL switch cannot be used to extend the measurement range. When the Log 90 dB scale is selected and the AMPLITUDE REF LEVEL switch is rotated away from the 0 dB (NORMAL) position, the meter reading is offset in steps of 10 dB. Each time the meter reading is offset, the full-scale reference becomes 10 dB lower as indicated by the white window. At the same time, however, the dynamic range decreases by 10 dB. With the AMPLITUDE REF LEVEL switch set to the -70 dB position, the full-scale reference is 70 dB below its original value but the dynamic range is only about 10 dB.

3-70. The ability to offset the meter reading on the Log 90 dB scale is useful for some measurement applications. In most cases, however, all measurements can be made with the AMPLITUDE REF LEVEL switch in the NORMAL position. Any time the AMPLITUDE REF LEVEL setting is changed from the NORMAL position, the dynamic range decreases and a possible worst-case error of ± 1 dB must be added to the amplitude accuracy specification.

3-71. When the Log 10 dB scale is selected, the meter sensitivity is increased to 1 dB per division over a 10 dB range. The Log 10 dB scale corresponds to the top 10 dB of the Log 90 dB scale. Thus, by offsetting the meter reading using the AMPLITUDE REF LEVEL control, any 10 dB portion of the 80 dB range can be selected. For the Log 10 dB scale, the black (dB) markings on the AMPLITUDE REF LEVEL switch dial indicate the full-scale level with respect to the 0 dB reference. For example, if the switch is set to the -10 dB position, the full-scale level is -10 dB and the meter scale ranges from -10 dB to -20 dB. Similarly, with the switch in the -60 dB position, the full-scale level is -60 dB and the meter scale ranges from -60 dB to -70 dB.

3-72. Amplitude Accuracy.

3-73. The Amplitude Accuracy specification listed in Table 1-1 is as follows:

AMPLITUDE ACCURACY	LOG	LINEAR
Frequency Response		
3581A and 3581C Unbalanced:		
15 Hz to 50 kHz	± 0.4 dB	$\pm 4\%$
3581C Balanced Inputs:		
40 Hz to 20 kHz	± 0.5 dB	$\pm 5\%$
Switching Between Bandwidths:	± 0.5 dB	$\pm 5\%$
Amplitude Display:	± 2 dB	$\pm 2\%$
Input Attenuator:	± 0.3 dB	$\pm 3\%$
Amplitude Reference Level (IF Attenuator)		
Most Sensitive Range:	± 1 dB	$\pm 10\%$
All Other Ranges:	± 1 dB	$\pm 3\%$

3-74. The Amplitude Accuracy specification is broken down so that portions of the specification that do not apply to a particular measurement can be eliminated. All applicable portions of the specification must be added together to obtain the overall accuracy specification. It should be noted that the overall accuracy specification reflects the absolute *worst-case* error that could possibly be encountered. Typically, all parameters are well within their specified tolerances and the probability of having a worst-case condition is very slight. As more parameters are added to the specification, the magnitude of the possible worst-case error increases but the probability of having a worst-case condition greatly decreases.

3-75. The Frequency Response, Amplitude Display and Input Attenuator specifications must always be taken into account when calculating the overall accuracy specification. Excluding the Switching Between Bandwidths and Amplitude Ref. Level specifications, the worst-case error is ± 2.7 dB in the Log mode or $\pm 9\%$ of reading in the Linear mode.

3-76. The Switching Between Bandwidths specification can be disregarded as long as the Amplitude Calibration Procedure is performed on the BANDWIDTH setting that is used for measurements. If the BANDWIDTH setting is changed, the Switching Between Bandwidths specification must be added to the overall accuracy specification. Similarly, the Amplitude Ref. Level specification can be disregarded as long as the AMPLITUDE REF LEVEL control is in the NORMAL position. If the AMPLITUDE REF LEVEL setting is changed, the Amplitude Ref. Level specification must also be added to the overall accuracy specification.

3-77. Internal Cal. Signal.

3-78. With the INPUT SENSITIVITY switch set to the CAL position, the high INPUT terminal on the front panel

is disconnected and an internally generated calibration signal is applied to the Input Amplifier. The calibration signal is a highly accurate 15/85 duty cycle pulse train which provides a 10 kHz fundamental frequency component along with odd and even harmonic components spaced at 10 kHz intervals (Figure 3-13). The magnitude of the pulse is such that the fundamental frequency component produces full scale deflection when the instrument is properly calibrated. The amplitudes of the harmonic components are not meaningful. The calibration signal can be used for amplitude calibration or to verify the frequency accuracy of the instrument.

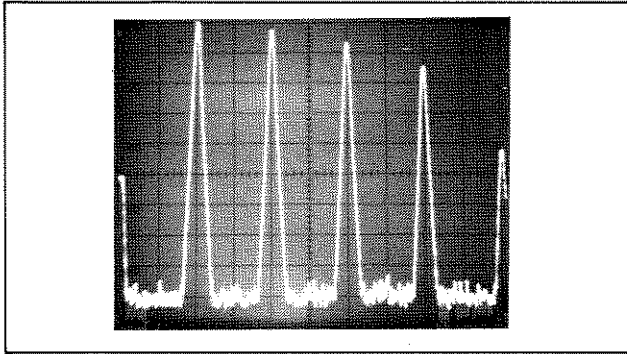

Figure 3-13. CAL Signal.

3-79. In the Amplitude Calibration Procedure (Paragraph 3-173), the front panel 10 kHz CAL potentiometer is adjusted so that the 10 kHz fundamental frequency component of the cal. signal produces full scale deflection. This calibrates all circuitry following the input attenuator to a full scale accuracy of $\pm 1.5\%$ at 10 kHz.

3-80. Bandwidth Setting.

3-81. Refer to Figure 3-14 for the following discussion. The 3581 uses a heterodyne technique where the 0 Hz to 50 kHz input signal is mixed with a 100 kHz to 150 kHz signal from a Voltage-Tuned Local Oscillator (VTO). To select a given frequency present at the input of the Mixer, the VTO frequency is tuned so that the difference between it and the frequency of interest is 100 kHz. The 100 kHz intermediate frequency (IF) is fed through the IF Filter, detected and applied to the meter. Signals outside the passband of the IF Filter are rejected. The BANDWIDTH setting determines the bandwidth of the IF Filter and thus, the selectivity of the instrument.

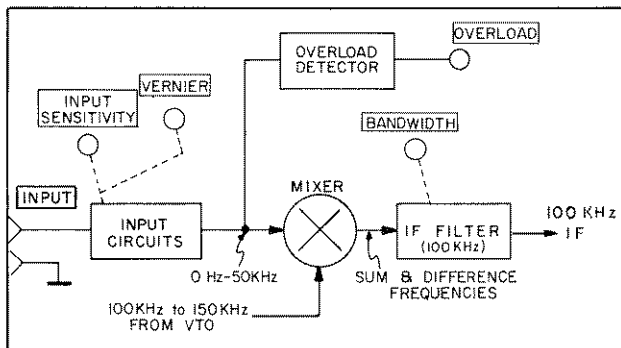

Figure 3-14. Frequency Tuning.

3-82. For operating purposes, the 3581 input channel can be pictured as a bandpass filter that can be manually tuned or swept over the 0 Hz to 50 kHz frequency range. The instrument responds only to signals passing through the filter and thereby sorts out the various frequency components present at the input. The BANDWIDTH setting determines the width of the filter skirts at the - 3 dB points above and below the tuned frequency:

$$\text{Lower 3 dB Point} = f_o - \frac{BW}{2}$$

$$\text{Upper 3 dB Point} = f_o + \frac{BW}{2}$$

Where:

f_o = Tuned Frequency (0 Hz to 50 kHz)

BW = BANDWIDTH Setting (3 Hz – 300 Hz)

3-83. **IF Bandpass Characteristic.** Many signal analyzers use active filters that have very steep skirts and a square-shaped bandpass characteristic that approaches the ideal “window filter”. This type of filtering provides a high degree of selectivity, but because of its long transient response time, is not well suited for swept frequency applications. The 3581 IF Filter consists of 5 synchronously-tuned crystal filter stages. The bandpass characteristic of the synchronously-tuned filter (Figure 3-15) closely approximates a gaussian response. The gaussian filter provides good selectivity and, because of its relatively short transient response time, is considered optimum for sweeping.

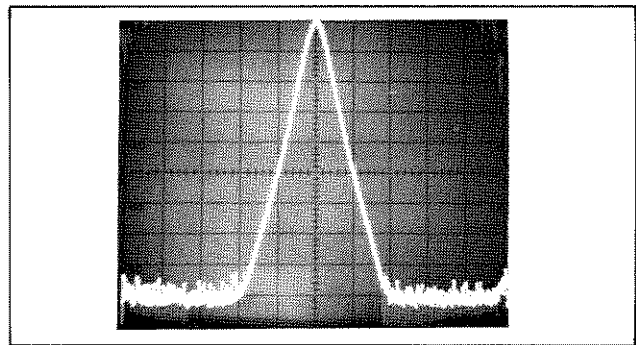

Figure 3-15. IF Filter Response.

3-84. **Shape Factor.** The shape factor of the 3581 IF Filter is approximately 10:1 on the 3 Hz through 100 Hz bandwidths and 8:1 on the 300 Hz bandwidth. A shape factor of 10:1 means that the filter skirts are 10 times wider at the - 60 dB points than at the - 3 dB points. Similarly, a shape factor of 8:1 means that the skirts are 8 times wider at the - 60 dB points than at the - 3 dB points. On the 10 Hz bandwidth, for example, the - 3 dB points are 10 Hz apart and the - 60 dB points are 10 x 10 or 100 Hz apart. The filter is, in effect, centered on the tuned frequency, f_o , and exhibits 3 dB of rejection to signals that are ± 5 Hz away from f_o and 60 dB of rejection to signals that are ± 50 Hz away from f_o .

3-85. Equivalent Noise Bandwidth. When making noise measurements with the 3581, it is necessary to use the "equivalent noise bandwidth" rather than the 3 dB bandwidth indicated by the BANDWIDTH setting. In the 3581, the equivalent noise bandwidth is 12% wider than the *absolute* 3 dB bandwidth. Note that the absolute 3 dB bandwidth can be about 15% wider or narrower than the BANDWIDTH setting. For optimum accuracy, measure the absolute 3 dB bandwidth of your instrument and use that figure to calculate the equivalent noise bandwidth.

3-86. Bandwidth Selection. There are 4 things to consider when selecting a BANDWIDTH setting:

- 1) Resolution
- 2) Low Frequency Limit
- 3) Response Time
- 4) Noise Rejection

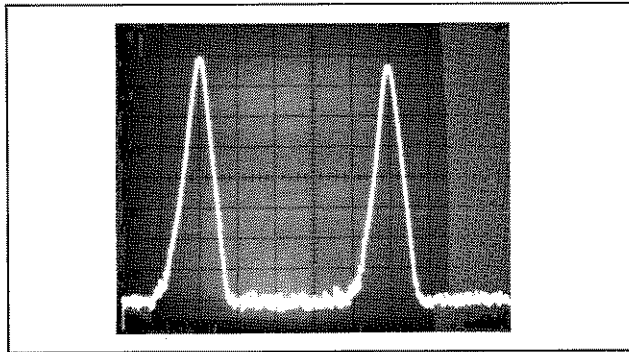

Figure 3-16. Response of CW Signals.

3-87. Resolution. Resolution is the ability of the analyzer to separate signals that are closely spaced in frequency. An important point here is that the response of the analyzer to a CW signal is an amplitude vs. frequency plot of the IF Filter (Figure 3-16). The width and shape of the filter skirts are, therefore, the major limitations of resolution. If two CW signals appear in the passband (± 3 dB points) simultaneously, they cannot be separated (Figure 3-17). If two signals differing widely in amplitude are both inside the filter skirts, the response of the larger signal can hide or obscure that of the smaller signal (Figure 3-18). If the

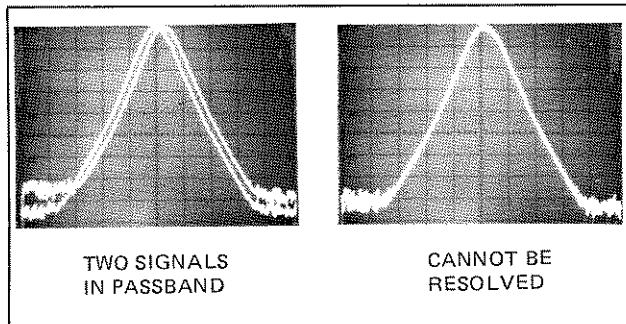

Figure 3-17. Two Signals in Passband.

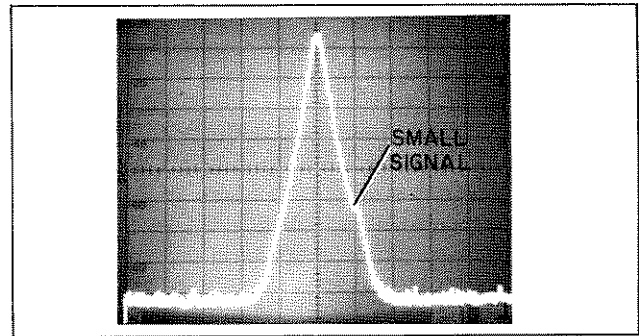

Figure 3-18. Large Signal Hides Small Signal.

amplitude of the smaller signal is greater than that of the skirt produced by the larger signal, the peak of the smaller signal can be resolved (Figure 3-19). For optimum resolution, the bandwidth should be narrowed to the point where only one signal is inside the filter skirts at any given time. Generally, the width of the filter skirts at the - 80 dB point does not exceed 15 times the 3 dB bandwidth. Thus, optimum resolution can always be obtained when the frequency separation between signals is at least 15 times the BANDWIDTH setting.

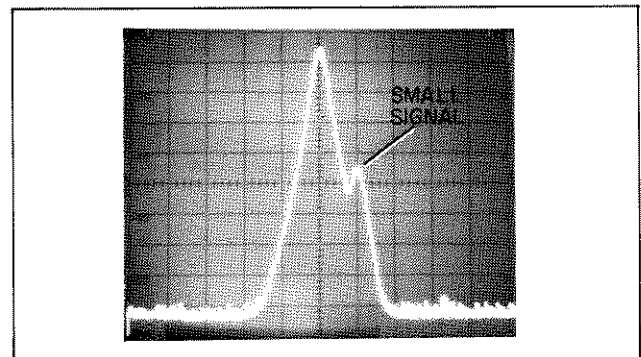

Figure 3-19. Small Signal Resolved.

3-88. Table 3-4 lists the *approximate* maximum resolution for two signals whose relative amplitude is within the range of 0 dB to 70 dB. For example, on the 100 Hz Bandwidth, it is possible to resolve two signals that are equal in amplitude and 2 X BW or 200 Hz apart. Similarly, it is possible to resolve two signals that differ in amplitude by 40 dB and are 5 X BW or 500 Hz apart.

Table 3-4. Frequency Resolution.

Ampl Difference	Max Resolution
0 dB	2 X BW
10 dB	2 X BW
20 dB	5 X BW
30 dB	5 X BW
40 dB	5 X BW
50 dB	10 X BW
60 dB	10 X BW
70 dB	10 X BW

BW = BANDWIDTH setting

3-89. Low Frequency Limit. To utilize the full dynamic range of the instrument at low frequencies, the lowest frequency to be resolved must be at least 5 times the selected BANDWIDTH. This low frequency limit is due to the zero response described in the following paragraphs.

3-90. As the 3581 frequency is tuned toward 0 Hz, the VTO frequency approaches the 100 kHz IF. Although the VTO signal is suppressed by the use of a double balanced mixer, part of the VTO signal feeds through the 100 kHz IF Filter and appears on the meter. The response produced by the VTO signal peaks at 0 Hz and is appropriately called the "zero response". As with any other CW signal, the zero response is an amplitude vs. frequency plot of the IF Filter (Figure 3-20). The wider the bandwidth, the wider the zero response.

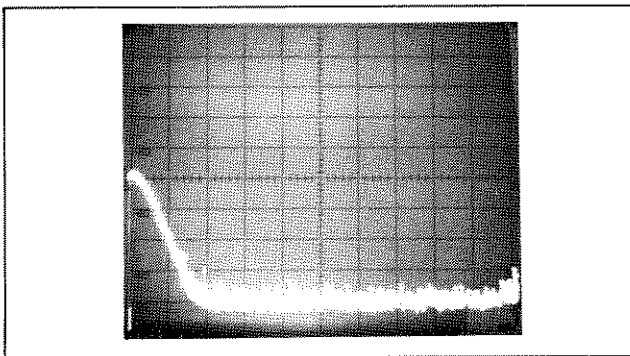

Figure 3-20. Zero Response (300 Hz BW).

3-91. The amplitude and bandwidth of the zero response determines the lowest frequency that can be resolved. For any BANDWIDTH setting, the peak amplitude of the zero response is more than 30 dB below the full scale reference set by the INPUT SENSITIVITY and amplitude VERNIER controls (AMPLITUDE REF LEVEL switch in NORMAL position). With the zero response more than 30 dB below full scale and a dynamic display range of 80 dB, the maximum difference between the peak of the zero response and any measureable input signal is between 40 dB and 50 dB. Table 3-4 indicates that the maximum resolution between two signals whose relative amplitude is between 40 dB and 50 dB is 5 times the BANDWIDTH setting.

3-92. Response Time. Generally, when making swept frequency measurements, it is desirable to have good resolution and, at the same time, sweep as rapidly as possible. This involves a definite trade off since the narrower bandwidths provide the greatest resolution but require slower sweep rates. As the bandwidth is narrowed, the IF Filter takes longer to respond to electrical changes taking place at its input. Consequently, the sweep rate must be slow so that the signal remains in the passband long enough for the filter to fully respond. Optimum sweep rate is discussed in Paragraph 3-122.

3-93. Noise Rejection. The maximum sensitivity of the analyzer is limited by its own internally generated noise. As

outlined in Paragraph 3-42, internal noise is a function of bandwidth, input resistance and tuned frequency. The narrower bandwidths provide the greatest noise rejection.

3-94. Frequency Setting.

3-95. The front panel FREQUENCY control tunes the frequency of the analyzer over the 0 Hz to 50 kHz range. The control can be used to manually tune the analyzer to a specific signal component or to set the start frequency of a sweep. The tuned frequency is indicated on the digital frequency display.

3-96. The FREQUENCY control has two selectable drive ratios to permit coarse or fine tuning. Coarse tuning is selected by pushing the knob toward the front panel; fine tuning is selected by pulling the knob outward. In the coarse position, one revolution of the knob changes the frequency by approximately 2.7 kHz. In the fine position, one revolution changes the frequency by approximately 73 Hz.

3-97. Frequency Display. The 3581 has a built-in frequency counter which provides a digital reading of the tuned frequency. The frequency display ranges from 0 Hz to approximately 51,000 Hz when the internal L.O. is used or from 0 Hz to 60,000 Hz when an external L.O. is used (Paragraph 3-148). Display resolution is 1 Hz. When the analyzer is tuned below 0 Hz, the frequency digits are blanked and the decimal points light to indicate an out of range condition.

3-98. The specified accuracy of the frequency display is ± 3 Hz. This means that when the analyzer is tuned to a given signal using AFC or by manually tuning for a peak amplitude reading, the frequency reading will be within ± 3 Hz of the signal frequency.

3-99. Automatic Frequency Control.

3-100. The purposes of the Automatic Frequency Control (AFC) are:

- a. To simplify manual tuning by automatically fine tuning the analyzer to the signal to be measured.
- b. To lock the analyzer's tuning to the signal component so that measurements are not affected by frequency drift and phase noise in the signal source (or 3581).

3-101. Pull-In Range. The "pull-in range" (sometimes called "capture range") is the frequency range over which the AFC can *acquire* lock. In order for the AFC to pull-in and lock to a signal, the 3581 must first be manually tuned to within the pull-in range above or below that signal. For example, if the pull-in range is ± 100 Hz and the signal to be measured is 1 kHz, the 3581 must be manually tuned between 900 Hz and 1100 Hz ($1 \text{ kHz} \pm 100 \text{ Hz}$). The

Table 3-5. Typical Pull-In Range.

Bandwidth Setting	LOG SCALE				VOLTS SCALE	
	SIGNAL AMPLITUDE* (dB below full scale)				SIGNAL AMPLITUDE* (percent of full scale)	
	0 dB to -30 dB	-30 dB to -60 dB	-60 dB to -70 dB*	-70 dB to -75 dB*	100% to 30%	30% to 10%
300 Hz	± 900 Hz	± 600 Hz	± 400 Hz	± 300 Hz	± 400 Hz	± 200 Hz
100 Hz	± 500 Hz	± 300 Hz	± 200 Hz	± 100 Hz	± 150 Hz	± 50 Hz
30 Hz	± 150 Hz	± 90 Hz	± 60 Hz	± 30 Hz	± 45 Hz	± 15 Hz
10 Hz	± 50 Hz	± 30 Hz	± 20 Hz	± 10 Hz	± 15 Hz	± 5 Hz
3 Hz	± 15 Hz	± 9 Hz	± 6 Hz	± 3 Hz	± 4 Hz	± 1 Hz

*To acquire lock, a signal must be at least 15 dB above noise floor.

pull-in range for the 3581 is determined by the BANDWIDTH setting, the SCALE setting and the signal amplitude. Typical pull-in ranges are listed in Table 3-5.

3-102. Hold-In Range. The “hold-in range” is the frequency range over which the AFC can *maintain* lock. The specified hold-in range for the 3581 is ± 800 Hz. This means that once the AFC is locked to a signal, the frequency of that signal can drift up to ± 800 Hz and the AFC will remain locked. Note, however, that the drift rate of the signal must be slow enough for the AFC to track properly. The maximum rate at which the AFC can track a signal is determined by the BANDWIDTH setting. As the bandwidth is narrowed, the AFC loop becomes slower and the maximum tracking rate decreases. Table 3-6 lists the *approximate* maximum frequency drift rate for each BANDWIDTH setting.

Table 3-6. Maximum Drift Rate.

BANDWIDTH	MAXIMUM DRIFT RATE
300 Hz	400 Hz/sec
100 Hz	400 Hz/sec
30 Hz	40 Hz/sec
10 Hz	4 Hz/sec
3 Hz	0.4 Hz/sec

3-103. Lock Frequency. The AFC Lock Frequency specification indicates that when the AFC is locked the input signal is less than ± 1 Hz away from the center of the passband. Due to component aging and environmental factors, the lock frequency may drift out of tolerance. This can be corrected by performing the Reference Oscillator Frequency Adjustment outlined in Section V.

3-104. Using the AFC. To use the AFC simply tune the analyzer to within the pull-in range of the signal to be measured and press the AFC button. The AFC UNLOCK annunciator will light, the frequency reading will change and the meter reading will increase as the analyzer is automatically tuned toward the signal frequency. When the analyzer is properly tuned or “locked” to the signal, the AFC UNLOCK annunciator will go out. Anytime the AFC is locked to a signal, the frequency reading will be within ± 3 Hz of the signal frequency.

3-105. The AFC circuit is designed to allow the analyzer to be manually tuned while the AFC is turned on. However, when the analyzer is not tuned near a signal component,

the AFC circuit may respond to noise signals. This makes the frequency unstable and causes the last digit of the frequency display to rack. Also, when the Volts scale is selected, the frequency tends to drift slowly in one direction. For these reasons, it is generally more convenient to leave the AFC off while manually tuning the analyzer. *The AFC should always be off when the analyzer is sweeping.*

3-106. Frequency Span Setting.

3-107. For electronic and manual sweeps, the FREQUENCY control is used to set the start frequency and the FREQ SPAN control is used to set the spectrum width or “end frequency”. Excluding the 0 Hz position, there are ten frequency span settings ranging from 50 Hz to 50 kHz.

3-108. 0 Hz Span. With the FREQ SPAN switch set to the 0 Hz position, the instrument remains at the frequency indicated on the frequency display. The sweep generator, however, remains operative and an X-Y recorder or storage scope connected to the Recorder outputs can be swept at the rate selected by the SWEEP TIME control. The result is a graphical display of amplitude vs. *time*.

3-109. The amplitude vs. time feature allows the 3581 to be used as an AM detector for observing the amplitude variations of a signal that occur over relatively long periods of time. For example, the amplitude of the 10 kHz sine wave shown in Figure 3-21A appears stable on a conventional oscilloscope but is actually varying at a very slow rate. Figure 3-21B shows an amplitude vs. time display of that signal for a 2,000 second period. The amplitude vs. time display shows that the 10 kHz signal is amplitude modulated by a triangular shaped signal whose frequency is 0.00166 Hz.

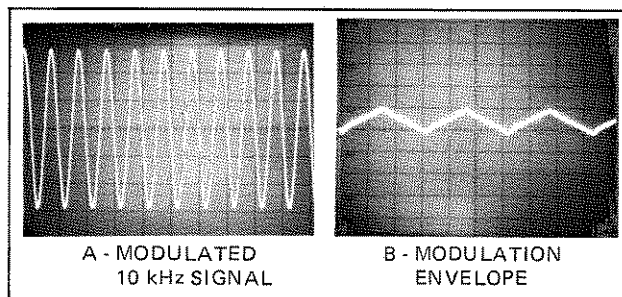

Figure 3-21. Amplitude vs. Time.

3-110. Because of its narrow bandwidth, the 3581 cannot respond to rapid changes in amplitude. When it is used as an

AM detector, the maximum modulating frequency to which it can respond properly is approximately 100 Hz for the 300 Hz BANDWIDTH setting.

3-111. Sweep Modes.

3-112. The front panel SWEEP MODE switch permits selection of five sweep modes:

- 1) REP (Repetitive)
- 2) SING (Single)
- 3) RESET
- 4) MAN (Manual)
- 5) OFF

3-113. Repetitive Mode. In the Repetitive sweep mode, the instrument sweeps continuously over the selected frequency range. The duration of each sweep is determined by the SWEEP TIME setting.

3-114. Single Mode. When the Single sweep mode is selected, the instrument sweeps one time over the selected frequency range and stops at the end frequency. The instrument remains at the end frequency until another sweep mode is selected or until a new sweep is initiated. A new sweep can be initiated by setting the SWEEP MODE switch to RESET and back to SINGLE. If the External Trigger line (Paragraph 3-129) is low when the sweep is reset, the new sweep will not start until a trigger is applied. However, the single sweep cannot be reset by an external trigger and must be reset manually.

3-115. The Single sweep mode is particularly useful for making single X-Y recordings where retrace is not desired. The operator can start the sweep, go about his business and return later to retrieve the completed recording.

3-116. Reset Mode. When the Reset mode is selected, the sweep generator resets, the X-Axis recorder output goes to 0 V and the instrument remains at the start frequency indicated on the frequency readout. The front panel ADJUST light (paragraph 3-124) is operative in the Reset mode, making it a convenient mode to use for setting sweep parameters.

3-117. Manual Mode. When the Manual mode is selected, the electronic frequency sweep is disabled and frequency control is transferred to the MANUAL VERNIER potentiometer. When the vernier control is fully counterclockwise, the instrument is at the start frequency set by the FREQUENCY control and the X-Axis recorder output is at 0 V. As the vernier is rotated in a clockwise direction, the frequency increases and the X-Axis output voltage increases just as it does with the electronic sweep. When the Vernier is fully clockwise, the instrument is at the end frequency determined by the FREQ SPAN setting and the X-Axis output is at +5 V. Since the manual sweep fully duplicates the span of the electronic sweep, it can be used to calibrate an X-Y recorder or scope connected to the Recorder outputs. The manual sweep can also be used for fine tuning with the FREQ SPAN set to 50 Hz.

3-118. Off Mode. When the Off sweep mode is selected, the sweep generator is reset just as it is in the Reset mode. The only difference is that the front panel ADJUST light is disabled in the Off mode. The Off mode is a convenient mode to use when manually tuning the analyzer.

3-119. Sweep Time and Sweep Rate.

3-120. Sweep Time Control. The front panel SWEEP TIME control provides 14 sweep time settings ranging from 0.1 second to 2,000 seconds.

3-121. Sweep Rate. The sweep rate in Hz per second is determined by the FREQ SPAN and SWEEP TIME settings:

$$R = \frac{F_s}{T}$$

Where:

$$\begin{aligned} R &= \text{sweep rate in Hz/sec} \\ F_s &= \text{FREQ SPAN setting} \\ T &= \text{SWEEP TIME setting} \end{aligned}$$

Increasing the frequency span or decreasing the sweep time increases the sweep rate.

3-122. Optimum Sweep Rate. The optimum sweep rate is the maximum rate at which the frequency can be swept without excessively compressing or skewing the amplitude response. When the 3581 is sweeping at what is considered to be the optimum rate, the amplitude compression is about 2%.

3-123. The optimum sweep rate is determined by the response time of the instrument. If the response time is long, the sweep rate must be slow so that the instrument can respond properly. The response time of the 3581 is determined by the BANDWIDTH and DISPLAY SMOOTHING settings. Narrowing the bandwidth or increasing the display smoothing increases the response time and, therefore, decreases the optimum sweep rate.

3-124. Optimum Sweep Indicator. The 3581 is equipped with an internal detector that monitors the BANDWIDTH, DISPLAY SMOOTHING, FREQUENCY SPAN and SWEEP TIME control settings. When these control settings are such that the sweep rate exceeds the optimum sweep rate, the front panel ADJUST indicator illuminates.

3-125. To sweep at the optimum rate, select the Reset mode and set the FREQUENCY, FREQUENCY SPAN, BANDWIDTH and DISPLAY SMOOTHING controls to obtain the desired measurement parameters. Then, starting with a slow SWEEP TIME setting, increase the sweep rate until the ADJUST light first comes on. When the ADJUST light comes on, rotate the SWEEP TIME control one position counterclockwise. The ADJUST light will go out and the instrument will be set to sweep at the optimum rate.

3-126. For closed-loop measurements where the 3581 is used as a network analyzer, the optimum sweep rate is determined by the 3581 BANDWIDTH and DISPLAY SMOOTHING control settings and by the bandwidth of the network under test. During closed-loop measurements, the input frequency is always near the center of the passband and the IF Filter is required to respond only to amplitude variations introduced by the network. For this reason, the optimum sweep rate for closed-loop measurements is generally much faster than it is for open-loop measurements. In many closed-loop measurement applications the sweep rate can be set 3 or 4 positions faster than the optimum rate indicated by the ADJUST light.

3-127. If the optimum sweep rate is not limited by the bandwidth of the 3581, it may be limited by the bandwidth of the network under test. For bandpass and low pass filters, a rough approximation of optimum sweep rate can be made using the following formula:

$$R = \frac{BW^2}{2}$$

Where:

R = optimum sweep rate in Hz/sec

BW = bandwidth of network under test

3-128. The bandwidth limitations and other variables such as the response time of an X-Y recorder make it difficult to predict the optimum sweep rate. When using an X-Y recorder the simplest approach is to start with a very slow sweep and, while observing the response curve, gradually increase the sweep rate until the amplitude of the response curve begins to compress (this may require several sweeps). At that point, the sweep rate is too fast. This same technique can be applied when using an oscilloscope. However, since the response time of a scope is much faster than that of an X-Y recorder, it is generally convenient to start with the optimum sweep rate set using the ADJUST light.

3-129. External Triggering.

3-130. The rear panel EXT TRIG IN connector enables the frequency sweep to be remotely triggered using a contact closure or TTL output. External triggering can be used in the Single or Repetitive sweep mode.

3-131. To remotely trigger the frequency sweep, apply the following levels to the center terminal of the EXT TRIG IN connector:

Sweep Inhibit: ground (thru $< 470 \Omega$) or
- 12 V dc to + 1.4 V dc

Sweep Trigger: open or + 4.5 V dc to + 20 V dc

NOTE

The outer shield of the EXT TRIG IN connector is connected to case ground. The center terminal of the connector is the trigger line.

3-132. The duration of the sweep trigger should be greater than 1 microsecond but less than the total sweep time. When the sweep is triggered in the Single sweep mode, the instrument sweeps one time and stops at the end frequency. The sweep must then be reset manually. This can be done by setting the SWEEP MODE switch to RESET and back to SING. If the trigger line is low when the sweep is reset, the new sweep will not begin until a trigger is applied. When the sweep is triggered in the Repetitive sweep mode, the instrument sweeps one time and resets to the start frequency. When the sweep resets, an internal 0.2 sec to 2 sec. delay is initiated to allow time for the IF Filter to settle. The sweep cannot be retriggered until *after* the delay is over. This applies to both the Single and Repetitive sweep modes. Table 3-7 lists the approximate delay time for each BANDWIDTH setting.

Table 3-7. Delay Times.

BANDWIDTH	DELAY
300 Hz	0.2 sec.
100 Hz	0.2 sec.
30 Hz	0.2 sec.
10 Hz	0.5 sec.
3 Hz	2 sec.

3-133. Recorder Outputs.

3-134. Recorder outputs are provided on the rear panel of the 3581 to permit the use of an external X-Y recorder/plotter or variable persistence scope. Two instruments recommended for use with the 3581 are:

-hp- Model 7035B Option 020 X-Y Recorder

-hp- Model 1201A/B Variable Persistence Oscilloscope

Although the Standard Model 7035B and other X-Y recorders can be used, the Option 020 is preferable because it has some special features that simplify scale calibration. In addition, the Model 7035B Option 020 has an X-Axis log converter which can be used to scale the 3581 linear sweep to provide a full log sweep over a 3-decade (10 Hz to 10 kHz) range.

3-135. **X-Axis Output.** The X-Axis output supplies a dc voltage proportional to the frequency sweep. When the sweep is at the start frequency, the output is 0 V dc; when the sweep is at the end frequency, the output is + 5 V dc. The output resistance is 1 kilohm, nominal.

3-136. During single and repetitive sweeps, the X-Axis output is a 0 V to + 5 V linear ramp. When the Manual sweep mode is selected, the X-Axis output voltage corresponds to the frequency set by the MANUAL VERNIER control. When the Reset or Off sweep mode is selected, the X-Axis output remains at 0 V.

3-137. **Y-Axis Output.** The Y-Axis output supplies a dc voltage proportional to the meter reading. The output level ranges from 0 V to + 5 V dc for zero to full scale meter

deflection. When the Volts scale is selected, an output of 0 V corresponds to a 0 V meter reading and an output of +5 V dc corresponds to a full-scale (1 or 3.2) meter reading. When the Log 90 dB scale is selected, the output voltage is scaled to 0.05 V per dB. An output of 0 V corresponds to -100 dB and an output of +5 V dc corresponds to 0 dB. When the Log 10 dB scale is selected, the output voltage is scaled to 0.5 V per dB. An output of 0 V corresponds to -10 dB and an output of +5 V corresponds to 0 dB. The output resistance is a 1 kilohm, nominal.

3-138. Pen Lift Output. The Pen Lift output is provided for use with X-Y recorders having electrically operated penlift circuits through which the pen can be remotely actuated by a contact closure. A contact closure is present across the Pen Lift output terminals during single and repetitive sweeps. The contacts open at the end of each sweep and do not close until after the sweep is reset. This prevents retrace lines from being drawn on the X-Y recording. The Pen Lift output terminals are isolated from case ground.

3-139. Rear Panel Output.

3-140. The rear panel OUTPUT connector is controlled by the OUTPUT MODE switch. With the switch in the TRACKING OSC position, the OUTPUT connector supplies a constant level 5 Hz to 50 kHz signal that tracks the tuned or swept frequency of the instrument. With the switch in the RESTORED position, the amplitude of the 5 Hz to 50 kHz output signal is proportional to the amplitude of the signal being measured. The constant level Tracking Oscillator signal can be used for making closed-loop frequency response measurements. The Restored output allows the 3581 to be used as a narrow band amplifier or bandpass filter.

3-141. The amplitude of the Tracking Oscillator or Restored output signal can be adjusted using the rear panel LEVEL control. When the output is not terminated or is driving a high impedance load, the signal level can be adjusted from 0 V to 2 V rms. The 3581A output is 600 ohms unbalanced while the 3581C output is 600 ohms balanced. When the output is terminated with a 600 ohm load, the maximum output level is approximately 1 V rms. The specified frequency response for the 3581A output is $\pm 3\%$ from 15 Hz to 50 kHz. The specified frequency response for the 3581C balanced output is ± 0.5 dB ($\pm 5\%$) from 100 Hz to 20 kHz. For both the 3581A and the 3581C outputs, the total harmonic distortion and spurious is more than 40 dB below a 1 V signal level.

3-142. The specified frequency accuracy of the output signal is 1 Hz relative to the center of the instrument's passband. This means that on the 3 Hz bandwidth the signal may be near the edge of the passband. This has no effect except when making closed-loop measurements where the

tracking oscillator signal is fed into the INPUT through a network under test. If the frequency is near the edge of the passband, insertion loss will be encountered. Under worst-case conditions, maximum insertion loss is approximately -1.5 dB. Typically, the insertion loss is less than 0.2 dB.

3-143. For most closed-loop measurements optimum results will be obtained using the 10 Hz or 30 Hz bandwidth. If the 3 Hz bandwidth is used, insertion loss can be minimized by performing the Reference Oscillator Frequency adjustment outlined in Section V.

3-144. L.O. Output.

3-145. The VTO in the 3581 generates a 1 MHz to 1.5 MHz signal which is divided to obtain the 100 kHz to 150 kHz local oscillator signal that is applied to the Input Mixer. The 1 MHz to 1.5 MHz VTO signal is available at the rear panel LOCAL OSCILLATOR OUT connector. The amplitude of the L.O. output signal is approximately 100 mV rms; output impedance is 1 kilohm, nominal.

3-146. If frequency resolution greater than 1 Hz is required, the tuned frequency of the instrument can be measured with an electronic counter connected to the L.O. output. Measurement accuracy is ± 5 Hz. The following formula can be used to calculate the tuned frequency from the counter reading:

$$F_t = \frac{F_c}{10} - 100 \text{ kHz}$$

Where:

$$F_t = \text{tuned frequency}$$

$$F_c = \text{counter reading}$$

3-147. The tuned frequency can also be measured using the 5 Hz to 50 kHz Tracking Oscillator signal. However, it is generally preferable to use the L.O. output signal because it can be measured with a 0.1 second gate time for fast response.

3-148. L.O. Input.

3-149. The 3581 can be remotely tuned by applying an externally generated L.O. signal to the rear panel LOCAL OSCILLATOR IN connector (MODE switch set to EXT). An external L.O. signal ranging from 1 MHz to 1.5 MHz tunes the 3581 from 0 Hz to 50 kHz. The frequency range of the instrument can be extended to 60 kHz by applying a 1.6 MHz L.O. signal. For measurements between 50 kHz and 60 kHz, a possible worst-case error of ± 3 dB or $\pm 30\%$ must be added to the Amplitude Accuracy specification.

3-150. The amplitude of the external L.O. signal must be within the range of 0.1 V rms to 1 V rms. The impedance of the L.O. Input is 220 ohms, nominal. In order for the 3581 to meet the frequency stability, noise sideband and spurious specifications listed in Table 1-1, the external Local Oscillator must have the same characteristics as the internal Local Oscillator (VTO). These characteristics are:

Frequency Stability: ± 5 Hz per $^{\circ}$ C
 Phase Noise: > 70 dB below L.O. signal level
 ± 10 X BW* away from L.O. frequency

Non-Harmonically
 Related Spurious: > 80 dB below L.O. signal level

*3581 BANDWIDTH setting

Any frequency drift, phase noise or spurious on the external L.O. signal will appear as if it is introduced by the input signal. Satisfactory results can generally be obtained using an -hp- Model 3320A/B or 3330A/B Frequency Synthesizer as the external L.O. source. Before using an external L.O. for a critical measurement application, check for noise sidebands and spurious using the Performance Test procedures outlined in Section V. In some cases, it may be helpful to run comparison tests between the internal L.O. and the external L.O.

3-151. Option 001.

3-152. The 3581 Option 001 is equipped with an internal rechargeable battery pack and a protective front panel cover for complete portability.

WARNING

To protect operating personnel, the 3581 Option 001 chassis must be grounded. For power line operation connect the power cord to a three-prong grounded receptacle. For battery operation connect the common (black) input terminal to earth ground or to an appropriate system ground. If a system ground is used be sure it is actually at ground potential and is not a voltage source.

3-153. The 3581 Option 001 can be operated from the ac power line or from its own internal battery pack. With the POWER switch set to the ON (AC) position, the instrument receives its power from the ac power line and a trickle charge is applied to the batteries. The trickle charge prevents the batteries from discharging, but is not sufficient to recharge the batteries in a reasonable time. With the POWER switch in the ON (BAT) position, the ac power is turned off and the instrument receives its power solely from the internal battery pack. A fully charged battery

pack will operate the instrument for more than 12 hours. When the batteries are discharged to the point where they cannot operate the instrument properly, the power is automatically shut off. This eliminates erroneous measurements caused by weak batteries and further prevents the batteries from being damaged due to excessive discharge.

3-154. To recharge the batteries, connect the instrument to an appropriate ac power source and set the POWER switch to the CHARGE position. The POWER light will illuminate. *The instrument cannot be operated while the batteries are being charged.* Recharge time for completely discharged batteries is 14 hours. The useful life of the batteries is more than 100 charge/discharge cycles.



The instrument should not be left in the CHARGE mode for prolonged periods. A charge period of 14 hours is sufficient to recharge a fully discharged battery pack. Extended periods of overcharge in ambient temperatures exceeding 30° C (86° F) will severely degrade battery life and capacity by causing the cells to overheat.

3-155. Temperature Limits. To prevent battery damage, the following temperature limits must be observed:

- a. Operating Temperature: 0° C ($+ 32^{\circ}$ F) to $+ 40^{\circ}$ C ($+ 104^{\circ}$ F).
- b. Charge Temperature Range: 0° C ($+ 32^{\circ}$ F) to $+ 40^{\circ}$ C ($+ 104^{\circ}$ F).
- c. Storage Temperature Range: -40° C ($- 40^{\circ}$ F) to $+ 50^{\circ}$ C ($+ 122^{\circ}$ F).

3-156. The 3581C.

3-157. The 3581C is a special version of the 3581 that is designed specifically for communications applications. The operating features of the 3581C are described in the following paragraphs.

3-158. Selectable Input Configurations. The 3581C has three selectable input configurations: Unbalanced, Balanced Bridged and Balanced Terminated. The selection is made using the front panel slide switch. The three input configurations are illustrated in Figure 3-22.

3-159. Unbalanced. The unbalanced input configuration is identical to the single-ended input of the 3581A. Because of the input switching, however, the shunt capacitance of the 3581C unbalanced input is approximately 40 pF as

opposed to 30 pF for the 3581A. If a 10:1 voltage divider probe is used with the 3581C, it must have sufficient adjustment range to compensate for the 40 pF shunt capacitance and the capacitance of any input adapter* that is used. The -hp- Model 10003A Voltage Divider Probe is recommended.

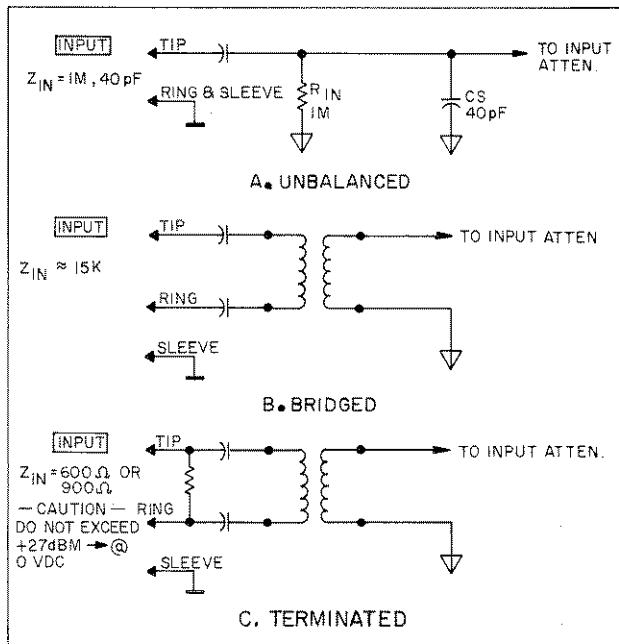

Figure 3-22. Input Configurations (3581C).

3-160. **Balanced Bridged.** The Balanced-Bridged configuration provides an unterminated, transformer-coupled balanced input. Coupling capacitors between the INPUT connector and the balancing transformer provide isolation for dc inputs up to ± 100 V dc. Inputs exceeding ± 100 V dc may damage the input circuitry. The maximum ac input level for the bridged input configuration is 35 V rms. The input impedance in Bridge is greater than 12 K ohms and typically 14 K ohms at 1 kHz.

3-161. **Balanced Terminated.** The Balanced Terminated configuration provides a transformer-coupled balanced input with an impedance of 600 ohms or 900 ohms. The input impedance is selected by the front panel dBm 900 ohm/LIN - dBm 600 ohm Calibration switch. Note that the 600 ohm or 900 ohm terminating resistor is connected directly across the input terminals. *There is no dc isolation for the termination.* The combined ac and dc levels applied to the terminated input must be such that the power dissipated by the terminating resistance is less than 0.5 watt. With no dc applied, the maximum ac differential input level is + 27 dBm.

* Recommended: Pamona Electronics No. 2798 Type 310 to BNC Adapter, -hp- Part No. 1251-3757.

CAUTION

The differential signal level applied to the 3581C Balanced Terminated input must not exceed + 27 dBm at 0 V dc. The combined ac and dc levels must be such that the power dissipated by the terminating resistor is less than 0.5 watt.

3-162. **Input Connector.** The 3581C INPUT connector accepts a Western Electric Type 310 (or equivalent) mating plug. See Figure 3-23 for details.

3-163. **Tracking Output.** The 3581C has a transformer-coupled, 600 ohm balanced Tracking Oscillator/Restored output. The specified frequency response for this output is ± 0.5 dB from 100 Hz to 20 kHz. The rear panel OUTPUT connector accepts a Western Electric Type 310 (or equivalent) mating plug (Figure 3-23).

3-164. **Audio Monitor.** The 3581C has a built-in audio amplifier and speaker which allows the operator to listen to the Tracking Oscillator or Restored output signal. The selection of Tracking Oscillator or Restored is made using the rear panel OUTPUT MODE switch. The volume can be adjusted using the AUDIO LEVEL control located on the front panel. Headphone connectors for the audio monitor are provided on the rear panel of the instrument. The connectors accept Western Electric Type 310 or Type 241 mating plugs (Figure 3-23). The impedance of the HEADSET output is 900 ohms, nominal. The maximum output level is 0 dBm/900 ohms. The output will drive headphones with impedances of 8 ohms or greater. The speaker is automatically switched off when a headphone is plugged in.

3-165. **Amplitude Measurements.** The 3581C can be calibrated for absolute measurements in dBm/600 ohms or dBm/900 ohms. The impedance is selected by the front panel dBm 900 ohm/LIN - dBm 600 ohm Calibration switch. The 3581C does not have a calibrated scale for measurements in dBV. The 3581C log scales can be used for relative measurements in dB; the linear scales can be used for relative measurements in percent of full scale.

3-166. **Manual Compatibility.** Except for the special features described previously, the 3581C is identical to the 3581A and most of the information in this section applies to both instruments.

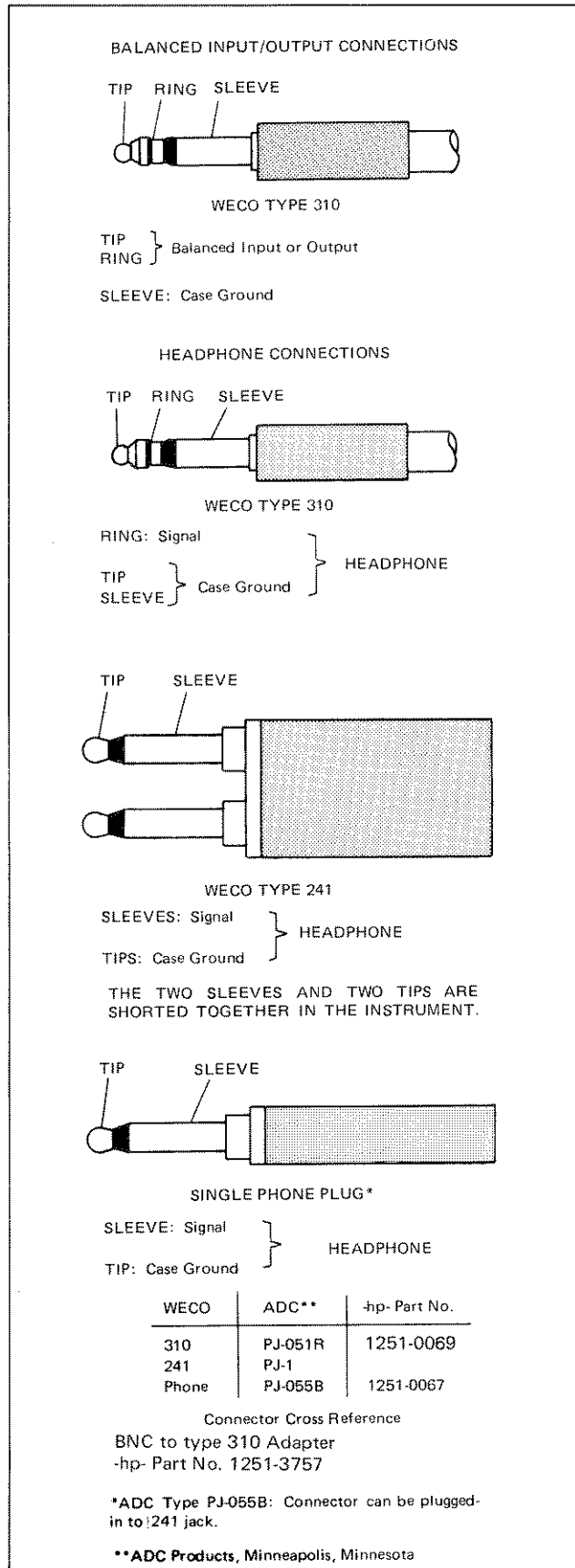

Figure 3-23. Input/Output Connectors (3581C).

3-167. BASIC OPERATING PROCEDURES.

3-168. Instrument Turn On.

3-169. Power Line Operation.

- a. Check the line voltage at the point of installation.
- b. Refer to Figure 3-24 and set the 3581 for the line voltage to be used (100 V, 120 V, 220 V or 240 V). Line voltage must be within + 5% to - 10% of voltage setting.

- c. Verify that the proper fuse is installed in the fuse holder:

Line Setting	Fuse Type	-hp- Part No.
100 V/120 V	0.5 A, 250 V Normal Blow	2110-0012
220 V/240 V	0.25 A, 250 V Normal Blow	2110-0004

- d. Connect the detachable ac power cord to the rear panel power receptacle and to the power source.

- e. Set the POWER switch to the ON (AC) position. The POWER light and the frequency display will illuminate.

- f. Allow a warm-up period of at least 5 minutes before using the 3581 in a critical measurement application.

3-170. Battery Operation (Option 001).

- a. Connect the low (black) terminal of the front panel INPUT connector to earth ground or to an appropriate system ground.

- b. Set the POWER switch to the ON (BAT) position. The POWER light and the frequency display will illuminate.

- c. Allow a warm-up period of at least 5 minutes before using the 3581 in a critical measurement application.

- d. To recharge the batteries, perform steps a through d of the power-line turn on procedure (Paragraph 3-169). Set the POWER switch to the CHARGE position. The POWER light will illuminate. The instrument cannot be used while the batteries are being charged.



The instrument should not be left in the CHARGE mode for prolonged periods. A charge period of 14 hours is sufficient to recharge a fully discharged battery pack. Extended periods of overcharge in ambient temperatures exceeding 30°C (86°F) will severely degrade battery life and capacity by causing the cells to overheat.

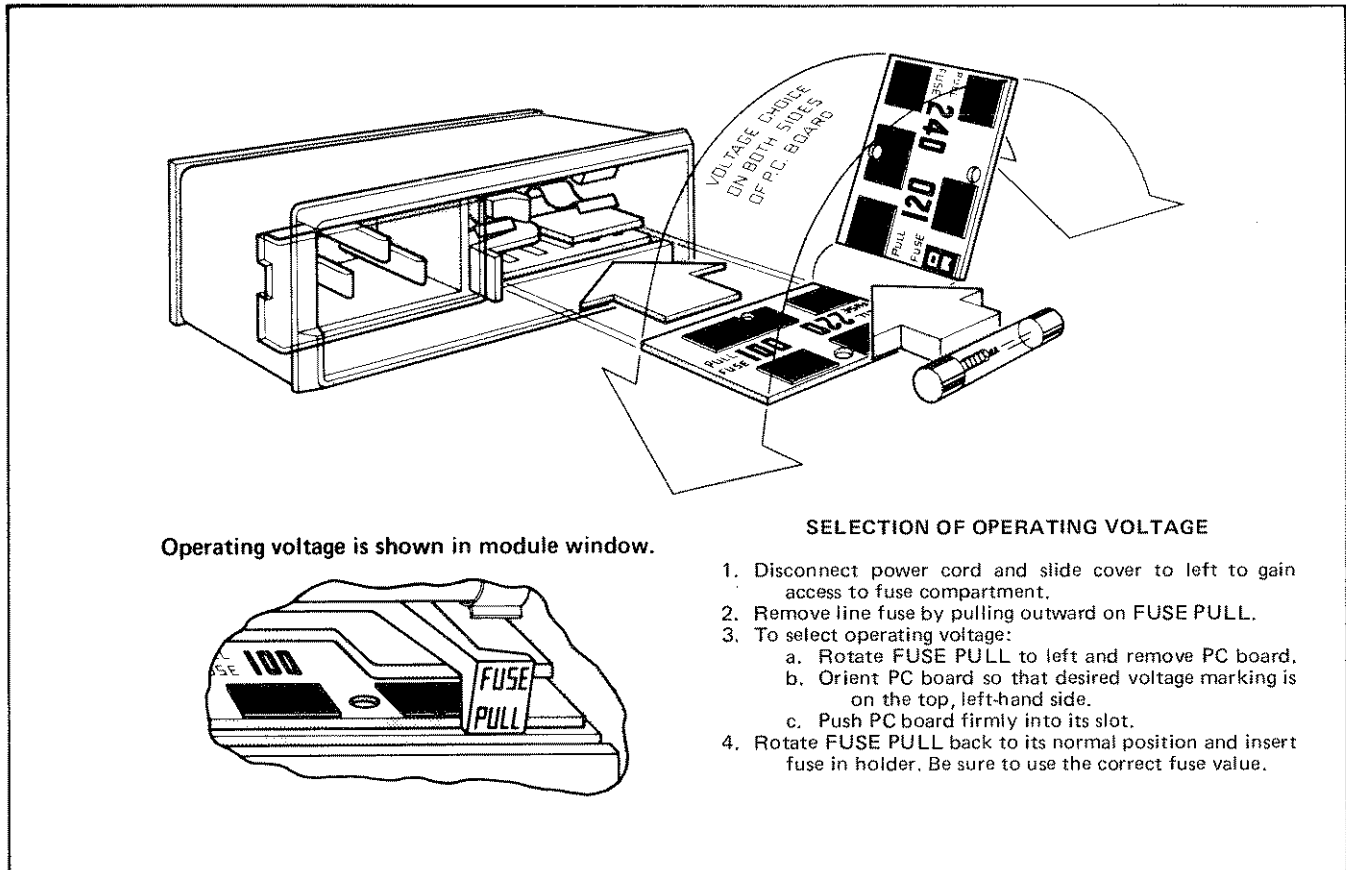

Figure 3-24. Voltage Selection.

3-171. Meter Mechanical Zero.

3-172. The meter is properly zero-set when the pointer rests over the zero calibration marks (0 to 1 or 0 to 3 scale) with the instrument turned off and in its normal operating environment. To zero the meter, proceed as follows:

- a. Turn the instrument on (Paragraph 3-168) and allow a warm-up period of 30 minutes so that the meter movement reaches its normal operating temperature.
- b. Turn the instrument off and allow 30 seconds for all capacitors to discharge.
- c. Rotate the zero adjustment screw clockwise until the pointer is left of zero and moving upscale.
- d. Continue rotating the screw clockwise and stop when the pointer is exactly over zero.
- e. When the pointer is exactly over zero, rotate the adjustment screw *slightly* counterclockwise to relieve tension on the pointer suspension. If the pointer moves off zero, repeat steps c through e.

3-173. Amplitude Calibration Procedure.

IMPORTANT

3-174. For optimum accuracy, the Amplitude Calibration Procedure should be performed when the instrument is first turned on, after warmup, each time the BANDWIDTH setting is changed and each time the SCALE setting is changed.

- a. Turn the instrument on (Paragraph 3-168) and, if necessary, mechanically zero the meter (Paragraph 3-171).
- b. Set the 3581A/C controls as follows:

SCALE	Setting to be used
AFC	Off
AMPLITUDE REF LEVEL	NORMAL
Calibration (dB/LIN) Switch	Setting to be used
INPUT SENSITIVITY	CAL
VERNIER (Amplitude)	CAL (fully CW)
BANDWIDTH	Setting to be used
DISPLAY SMOOTHING	MIN
SWEEP MODE	OFF
- c. Tune the 3581 frequency near 10,000 Hz and press the AFC button. The AFC will fine tune the analyzer to the

10 kHz calibration signal. If AFC is not to be used, manually fine tune for a peak amplitude reading at 10,000 Hz.

d. Using a small screwdriver, adjust the front panel CAL 10 kHz potentiometer for a full-scale meter reading.

3-175. Input Probe Compensation.

3-176. Before using a 10:1 divider probe, it is necessary to adjust the probe for optimum frequency response. Once the probe is properly adjusted it should not require further attention. It is good practice, however, to perform periodic verification tests to ensure that optimum adjustment is maintained.

a. Turn the instrument on as outlined in Paragraph 3-168.

b. Connect the probe to the 3581 INPUT.

1. 3581A: Use a BNC to banana-plug adapter (-hp Part No. 1251-2277).

2. 3581C: Use a BNC to Type 310 adapter (Pamona Electronics No. 2798).

c. Set the 3581A/C controls as follows:

SCALE Log 90 dB
 AFC Off
 AMPLITUDE REF LEVEL NORMAL
 Calibration Switch dBV/LIN (3581A)
 dBm 900Ω/LIN (3581C)
 INPUT SENSITIVITY - 10 dB
 Amplitude VERNIER fully CCW
 BANDWIDTH 3 Hz
 DISPLAY SMOOTHING MIN
 FREQ SPAN 5 kHz
 SWEEP MOD MAN
 MANUAL VERNIER fully CCW

d. Set the rear panel OUTPUT MODE switch to the TRACKING OSC position. Rotate the LEVEL control fully clockwise (facing rear panel).

e. Connect the probe tip to the rear panel OUTPUT connector. Connect the ground lead of the probe to the connector shield.

f. Using the FREQUENCY control, set the 3581A frequency to 100 Hz; set the 3581C frequency to 500 Hz. Press the Log 10 dB SCALE button.

g. Adjust the amplitude VERNIER for a meter reading of - 5 dB (0 to - 10 dB scale).

h. Rotate the MANUAL VERNIER control fully clockwise. This will set the 3581A frequency to approximately 5,100 Hz or the 3581C frequency to 5,500 Hz.

i. Adjust the probe for a meter reading of - 5 dB. Rotate the MANUAL VERNIER fully counterclockwise.

j. Repeat steps g through i until the meter reading is - 5 dB with the MANUAL VERNIER fully clockwise and fully counterclockwise.

3-177. Recorder Calibration.

3-178. The following is a general procedure for calibrating an X-Y recorder or oscilloscope connected to the rear panel RECORDER outputs.

a. Perform the Amplitude Calibration Procedure (Paragraph 3-173).

b. Set the 3581A/C controls as follows:

SCALE VOLTS
 AFC Off
 AMPLITUDE REF LEVEL NORMAL
 Calibration Switch dBV/LIN (3581A)
 dBm 900 Ω/LIN(3581C)
 INPUT SENSITIVITY CAL
 Amplitude VERNIER CAL
 BANDWIDTH 30 Hz
 SWEEP MODE MAN
 MANUAL VERNIER fully CCW

c. Connect the X-Axis input of the X-Y recorder or horizontal input of the scope to the rear panel X-Axis output connector.

d. Adjust the X-Axis zero of recorder or horizontal position of scope so that the pen or CRT dot is aligned with the first vertical line on the left-hand edge of the graph paper or display graticule.

e. Rotate the MANUAL VERNIER control fully clockwise.

f. Adjust the X-Axis gain of recorder or horizontal gain of scope so that the pen or CRT dot is aligned with the last vertical line on the right-hand edge of the graph paper or display graticule.

g. Rotate the MANUAL VERNIER fully counterclockwise. Repeat steps d through f until optimum adjustment is obtained.

h. Set the 3581 SWEEP MODE switch to RESET. Using the FREQUENCY control, tune the analyzer frequency to 5 kHz so that it is not measuring a signal. The meter should read 0 V.

i. Connect the Y-Axis input of the recorder or vertical input of scope to the rear panel Y-Axis output connector.

j. Adjust the Y-Axis zero of recorder or vertical position of scope so that the pen or CRT dot is aligned with the bottom line of the graph paper or display graticule.

k. Tune the analyzer frequency to 10,000 Hz and press the AFC button. The 10 kHz calibration signal will produce a full scale meter reading.

NOTE

The Y-Axis recorder output ranges from 0 V to + 5 V dc. When the Log 90 dB scale is selected, an output of 0 V corresponds to - 100 dB and + 5 V corresponds to 0 dB (0.05 V/dB). When using the Log 90 dB (or 10 dB) scale, it is convenient to calibrate the X-Y recorder (step l) so that full-scale (0 dB) is 10 major divisions above the bottom line (- 100 dB) of the graph paper. Each major division then represents 10 dB for the Log 90 dB scale or 1 dB for the

Log 10 dB scale. This same method can be used for calibrating a scope if it has 10 vertical divisions. If the scope has 8 vertical divisions, it can be calibrated so that full scale is 5 divisions above the bottom line of the graticule. Each major division then represents 20 dB.

l. Adjust the Y-Axis gain of recorder or vertical gain of scope so that the pen or CRT dot is aligned with the top line (or other line representing full scale) of the graph paper or display graticule. Tune the analyzer frequency to 5 kHz.

m. Repeat steps j through l until optimum adjustment is obtained.

n. This completes the Recorder Calibration Procedure. Connect the pen-lift input of the recorder to the PEN-LIFT output of the 3581. Set sweep parameters with the SWEEP MODE switch set to the RESET position. Be sure to turn the AFC off before sweeping.

